

1970
1980
1990
2000
2010

PRESOCO 2020 CATALOGUE

EDITION 33

Exclusive NEW discounts
and GIFTS see page 4

LAMINATING
page 6

BINDING
page 19

TAPES
page 40

DISPLAY
page 58

FINISHING
page 78

Presco ✓

- ✓ Huge stocks for rapid next day delivery
- ✓ Genuine product experience and advice
- ✓ New products to keep up with market trends
- ✓ Specials department for any custom product
- ✓ Prices – we will match or beat any quote
- ✓ Trust – we look after customers better, every time

Welcome!



Hundreds of print finishing products can be found on our website presco.eu

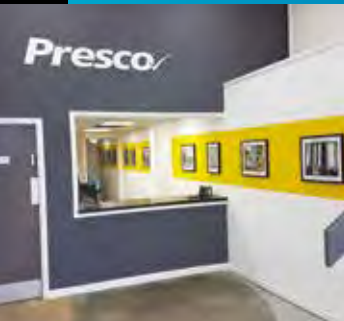

Trade counter for immediate collection 7am-5pm Mon-Fri in Swindon, SN2 2NP

Presco

Experts in digital print finishing supplies.



Call **01793 716300** for free help, advice and samples.

This is a trade priced catalogue and all prices shown exclude VAT. Please see online for latest delivery costs and options. Prices can change without notice, current pricing can be found online at presco.eu. Order by 4pm for next day delivery. Full Terms & Conditions of sale available online.

Catalogue and all content copyright © Presco 2019.



LAMINATING FILMS

Pages 6–18

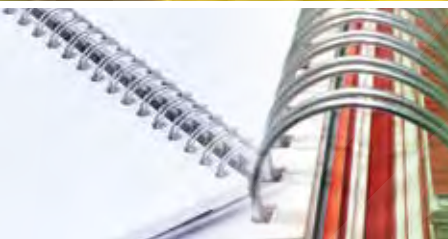

BINDING SUPPLIES

Pages 19–39



ADHESIVE TAPES

Pages 40–55



CUSTOMISED SPECIALS

Pages 56–57

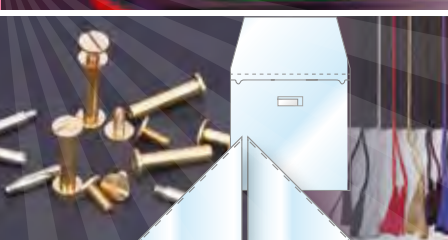

DISPLAY & FIXING

Pages 58–77

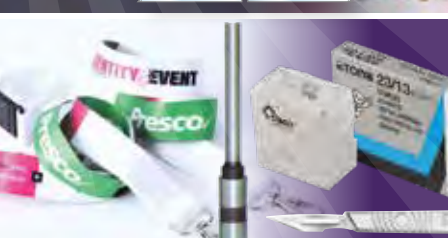

HAND FINISHING & ID

Pages 78–101

SEE INDEX to find specific products **Pages 102–104**

Coming next – watch out for these offers!



**FREE
DELIVERY**

**FREE DELIVERY ON
BINDING WIRE SPOOLS**

**20%
OFF**



**20% OFF
LAMINATES**



**FREE
GIFTS**

**WINES, HAMPERS AND
XMAS GIFT SETS**

**15%
OFF**



**15% OFF TASSELS &
ELASTICS**



**FREE
GIFTS**

**FREE GIFTS WITH
ORDERS**

**UP TO
20%
OFF**



**SAVE ON WIRE BINDING,
UP TO 20% OFF**

**UP TO
20%
OFF**



**SAVE ON FIXINGS AND POS
FITTINGS, UP TO 20% OFF**

**FREE
GIFTS**



**FREE GIFTS
GIVEAWAY**

**UP TO
30%
OFF**



**SAVE ON NEW MACHINES,
UP TO 30% OFF**

**HUGE
GIVEAWAY**

**Presco
Giveaway!**

**HUGE SUMMER
GIVEAWAY!**

Get advance notice of our offers - sign up at presco.eu/news

WE'RE SERIOUS ABOUT REWARDING YOU!

Join the thousands of customers who shop with us and have received a selection of fabulous gifts.

In the past year we've given away...

- ☛ 7,450 cans of beer
 - ☛ Over 300 footballs
 - ☛ 178 bottles of Prosecco
 - ☛ 215 fire pit BBQs
 - ☛ 235 extra large chocolate eggs
- ... and much more!



Get our news updates to claim
– visit presco.eu/news

IN THIS SECTION

LAMINATING FILMS – pages 7–10

ROLL LAMINATING MACHINES – page 11

LAMINATING POUCHES – page 12–13

POUCH LAMINATORS – page 14

ENCAPSULATION FILMS – pages 15–18



LAMINATING FILMS

High quality Presco OPP thermal laminating films for all print. Laminating digital print doesn't need to be complicated, you may just need to use a stronger adhesive, like our level 5 or level 7 films.

GUIDE TO FILM ADHESIVE STRENGTH LEVELS

FOR LAMINATING FILMS

ADHESIVE LEVEL

3 The industry standard for everyday laminating but is not suitable for heavy ink coverage and some digital work.

5 Level 5 is the highest adhesion available from most suppliers. Digital printers are increasingly using this for reliable results.

7 The top level when no other laminate will stick. It will give a super high adhesion.

LAMINATION & ENCAPSULATION - WHAT'S THE DIFFERENCE?

The word 'laminating' is used to talk about laminating, pouch laminating and encapsulating, but there are differences. Lamination is usually a single sided process for enhancement of print. Encapsulation is a double sided process that completely seals the print and is primarily for protection, not enhancement, of print. Pouch laminators completely enclose the print, so they are actually mini encapsulation machines, not laminators! New digital laminates for use with roll laminators now have many different options to enhance your print and transform it into something special.

NEW!

Presco

Showcase Laminating Films including our Ultimate Gloss and Matt as well as special effect films such as Holographic, Textured, Soft Touch and more.

KEY LAMINATING FILMS

Presco STANDARD

ADHESIVE
LEVEL

3

A great film for everyday laminating. Long proven by our customers, it is great for laminating basic litho print and some digital work. Available in matt or gloss.



MATT 25MM CORE (1")

Width	Length	Thickness	Ref	Price
315mm	200m	28mic	6783	£14.18
440mm	200m	28mic	6785	£20.14
630mm	200m	28mic	6787	£24.16

MATT 76MM CORE (3")

Width	Length	Thickness	Ref	Price
315mm	1000m	28mic	6790	£37.50
315mm	3000m	28mic	6790	£103.56
440mm	1000m	28mic	6791	£52.06
440mm	3000m	28mic	6791	£144.32

GLOSS 25MM CORE (1")

Width	Length	Thickness	Ref	Price
315mm	200m	25mic	6773	£12.01
440mm	200m	25mic	6775	£16.78
630mm	200m	25mic	6777	£24.02

GLOSS 76MM CORE (3")

Width	Length	Thickness	Ref	Price
315mm	1000m	25mic	6788	£31.25
315mm	3000m	25mic	6788	£86.42
440mm	1000m	25mic	6789	£43.33
440mm	3000m	25mic	6789	£120.40

Presco PREMIUM

ADHESIVE
LEVEL

5

This is a great digital print laminating film which some customers use on all work for quality assurance. A market leading digital film with fantastic adhesion properties. Generally this level of adhesion would be the highest available from most suppliers. Available in matt or gloss.

MATT 25MM CORE (1")

Width	Length	Thickness	Ref	Price
315mm	125m	43mic	6654	£32.45
440mm	125m	43mic	6656	£45.31
630mm	125m	43mic	6658	£64.90

MATT 76MM CORE (3")

Width	Length	Thickness	Ref	Price
315mm	500m	43mic	6691	72.07
315mm	1000m	27mic	6693	97.19
440mm	500m	43mic	6692	£100.69
440mm	1000m	27mic	6694	£135.41

GLOSS 25MM CORE (1")

Width	Length	Thickness	Ref	Price
315mm	125m	40mic	6667	£30.78
440mm	125m	40mic	6669	£43.02
630mm	125m	40mic	6671	£61.60

GLOSS 76MM CORE (3")

Width	Length	Thickness	Ref	Price
315mm	500m	40mic	6681	£68.41
315mm	1000m	24mic	6683	£81.90
440mm	500m	40mic	6682	£95.55
440mm	1000m	24mic	6684	£118.64

Presco ULTIMATE

ADHESIVE
LEVEL

7

THE No.1 DIGITAL LAMINATING FILM

The film to try if you are having adhesion problems. With ultimate strength digital adhesive, this has been the film that saves the day by doing what no other higher adhesive OPP could do!

MATT 25MM CORE (1")

Width	Length	Thickness	Ref	Price
315mm	125m	43mic	6707	£43.61
440mm	125m	43mic	6709	£60.89

MATT 76MM CORE (3")

Width	Length	Thickness	Ref	Price
315mm	500m	40mic	6701	£94.64
315mm	1000m	40mic	6701	£189.28
440mm	500m	40mic	6703	£132.20
440mm	1000m	40mic	6703	£264.39

GLOSS 25MM CORE (1")

Width	Length	Thickness	Ref	Price
315mm	125m	40mic	6712	£40.06
440mm	125m	40mic	6714	£55.93

GLOSS 76MM CORE (3")

Width	Length	Thickness	Ref	Price
315mm	500m	40mic	6700	£92.84
315mm	1000m	40mic	6700	£185.67
440mm	500m	40mic	6702	£129.65
440mm	1000m	40mic	6702	£259.35

Presco SOFT-TOUCH ULTIMATE

ADHESIVE
LEVEL

7

This ultra-matt, soft-touch or 'velvet' feel film is becoming really popular. It gives a distinctive aesthetic effect with the dead matt, and the soft feel of this unique film. Our brand is particularly designed to not easily show marks from handling and uses our strongest adhesive level for use with any type of print. You can use foil on this film for layered effects, to get a perfect result we advise testing before production.

SOFT-TOUCH 25MM CORE (1")

Width	Length	Thickness	Ref	Price
315mm	125m	43mic	6685	£41.95
440mm	125m	43mic	6688	£58.59

SOFT-TOUCH 76MM CORE (3")

Width	Length	Thickness	Ref	Price
315mm	500m	43mic	6696	£137.60
440mm	500m	43mic	6697	£192.20



SHOWCASE LAMINATING FILMS

Our most innovative laminating films. From ultimate gloss to textured film and holographics – these laminates will transform your print into something special. View and buy at presco.eu/showcase

Presco✓ ANTI BACTERIAL MATT

ADHESIVE
LEVEL

3

A unique laminating film designed to resist and remove bacteria on a printed surface. For use in sensitive industries from food production to medical or educational environments as well as restaurant menus and children's books. Other uses include hospital communications and packaging of personal care items. Food approved.



76MM CORE (3")

Width	Length	Thickness	Ref	Price
315mm	500m	27mic	6803	£46.33
440mm	500m	27mic	6805	£64.35

Presco✓ ANTI SCRATCH MATT

ADHESIVE
LEVEL

5

Anti scratch digital laminating film (also known as anti-scuff) is a thin and hard wearing matt laminating film with an extra hard coating that will not easily scratch or scuff, allowing the printed matter to retain its integrity for much longer.



76MM CORE (3")

Width	Length	Thickness	Ref	Price
315mm	500m	30mic	6698	£121.52
440mm	500m	30mic	6699	£169.36

Presco✓ HOLOGRAPHIC SPLINTER

ADHESIVE
LEVEL

3

A vibrant holographic laminating film – fractured crystals 5-10mm size, very noticeable and colourful without obscuring text, but adding a layer of interest.



76MM CORE (3")

Width	Length	Thickness	Ref	Price
315mm	500m	28mic	6857	£109.06
440mm	500m	28mic	6859	£151.96

Presco✓ HOLOGRAPHIC BUBBLES

ADHESIVE
LEVEL

3

A startling and noticeable holographic laminating film – the most 'busy' of our holographic films, made up of hundreds of tiny holographic 'bubbles' that make for interesting packaging opportunities.

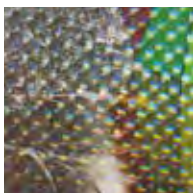

76MM CORE (3")

Width	Length	Thickness	Ref	Price
315mm	500m	28mic	6847	£109.06
440mm	500m	28mic	6849	£151.96

Presco HOLOGRAPHIC MAX

ADHESIVE
LEVEL

3

A classic and striking holographic film. Adds depth and atmosphere to any printed material. No detailed holographic pattern, the effect is more like adding an extra layer of reflective colour. Best seen in real life, request a sample from us to see this product. Gloss finish.

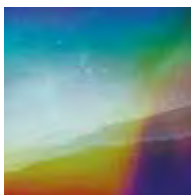

76MM CORE (3")

Width	Length	Thickness	Ref	Price
315mm	500m	28mic	6841	£109.06
440mm	500m	28mic	6843	£151.96

Presco HOLOGRAPHIC STARBURST

ADHESIVE
LEVEL

3

Film with a sparkle! A detailed pattern of small (2-5mm) holographic stars on a thin gloss laminating film that will cover print with a noticeable 'flash' that catches the eye. Ideal for festive or winter packaging applications.



76MM CORE (3")

Width	Length	Thickness	Ref	Price
315mm	500m	28mic	6851	£109.06
440mm	500m	28mic	6853	£151.96

Presco TEXTURED LEATHERGRAIN

ADHESIVE
LEVEL

3

A textured matt laminating film with a slightly embossed leather effect. Use for distinctive packaging, promotional or branding materials.



76MM CORE (3")

Width	Length	Thickness	Ref	Price
315mm	500m	50mic	6866	£159.92
440mm	500m	50mic	6868	£223.02

Presco TEXTURED LINEN

ADHESIVE
LEVEL

3

Linen textured laminating film with a matt finish and the slight embossed effect for creative packaging, print and more.



76MM CORE (3")

Width	Length	Thickness	Ref	Price
315mm	500m	50mic	6871	£159.92
440mm	500m	50mic	6873	£223.02

Presco SATIN

ADHESIVE
LEVEL

3

Satin is a smooth film in between matt and gloss finishes, with some reflectivity and depth, but the feel of matt film. Gives a more subtle finish than gloss, ask for samples to see it in real life.



76MM CORE (3")

Width	Length	Thickness	Ref	Price
315mm	500m	27mic	6811	£43.10
440mm	500m	27mic	6813	£59.81

LAMINATE & ENCAPSULATE WITH ONE MACHINE – two solutions from **Presco**

PRESKO 360 ROLL LAMINATOR

The Presco 360 is a compact, versatile roll laminator, a great option for copy shops and smaller print rooms where space is tight. This has a slitting and perforation unit fitted as standard. With adjustable roller pressure and an adjustable anti-curl roller, this can handle a wide variety of jobs, from traditional encapsulation to digital lamination and special effect lamination.



KEY FEATURES

- Max film width: 350mm
- Warm up time: 10 mins
- Speed adjustment: 0.3–2m/min
- Compatible core sizes: 1" & 3" core adaptors included

See this in action!

 go to presco.eu/360

Product	Ref	Price
Presco 360 Roll Laminator	0570	£1,095.00

COMPACT & EFFICIENT

Start laminating with regular or showcase films right away.

MATRIX DUO LAMINATORS



One of our best selling laminators, the Matrix Duo 460 will accommodate sheets up to 460mm in width. If your laminating requirement is for single sided, double sided and encapsulation up to SRA1, then the Matrix Duo 650 is the ideal choice.

With variable temperature settings and variable speeds up to 1.6 metres per minute, this is a very flexible laminator.



KEY FEATURES

- Variable speed control to 1.6m/min
- Solid construction heavy duty system
- Anti-jam reverse mechanism
- Attached safety shield
- Independent heated rollers

Product	Ref	Price
Matrix Duo 460 Laminator	0594	Call us
Matrix Duo 650 Laminator	0596	Call us
Stand for Matrix Duo 650 Laminator	0597	Call us

LAMINATING POUCHES

GLOSS POUCHES



View 10+
quantity
break pricing
online at
presco.eu

Gloss laminating pouches to finish and protect any printed sheet. Available from credit card sizes right up to A1. All pack sizes 100 unless otherwise stated.

Size	Dimensions	Thick-ness	Ref	Price
Credit card	54x86mm	350mic	7031	£3.46
Business card	67x98mm	250mic	7032	£2.58
Business card	67x98mm	350mic	7033	£2.51
IBM	59x83mm	350mic	7034	£2.30
Business card	60x90mm	350mic	7035	£3.29
ID card	64x99mm	250mic	7037	£3.03
ID card	64x99mm	350mic	7038	£3.29
ID card	65x95mm	350mic	7040	£3.72
ID card – slot on long edge	95x65mm	350mic	7041	£6.40
ID card – slot on short edge	64x108mm	350mic	7044	£5.71
ID card	65x108mm	250mic	7045	£2.22
ID card	65x108mm	350mic	7046	£2.36

Size	Dimensions	Thick-ness	Ref	Price
A7 exact	74x104mm	350mic	7050	£5.71
A7 oversized	80x111mm	350mic	7051	£5.71
A6	111x154mm	250mic	7060	£6.75
		350mic	7061	£7.09
A5	154x216mm	150mic	1001	£5.69
		200mic	1003	£7.29
		250mic	1005	£8.47
		350mic	1008	£14.80
A4	216x302mm	500mic	1011	£18.80
		150mic	1019	£7.77
		200mic	1022	£10.66
		250mic	1025	£13.39
		350mic	1028	£21.57
A3	302x425mm	500mic	1031	£25.00
		150mic	1039	£16.84
		200mic	1042	£21.04
		250mic	1045	£26.35
A2	425x600mm	350mic	1048	£43.55
		500mic	1051	£72.22
		150mic	1089	£32.86
		200mic	1093	£41.43
A1 (pack of 25)	600x846mm	250mic	1090	£51.92
		250mic	1092	£101.85

MATT POUCHES

Laminating pouches with a dull matt finish for a more contemporary look and feel. Eliminates glare found with gloss laminating pouches.

Size	Dimensions	Thickness	Ref	Price
A5	154x216mm	150mic	1070	£8.37
		200mic	1071	£9.57
		250mic	1072	£11.31
A4	216x302mm	150mic	1054	£15.58
		200mic	1056	£21.62
		250mic	1055	£25.57
		350mic	1057	£36.47

Size	Dimensions	Thickness	Ref	Price
A3	302x425mm	150mic	1079	£32.37
		200mic	1081	£39.29
		250mic	1080	£43.45
		350mic	1082	£61.37
A2	425x600mm	150mic	1087	£54.56
		250mic	1088	£76.67

SELF SEAL POUCHES

Adhesive self-sealing pouches that do not require a thermal pouch laminator. Simply insert the document, pull off the pouch backing paper and stick down. Two part pouch with a thick glossy front material of 250 micron and a glossy adhesive back layer of 60 micron.

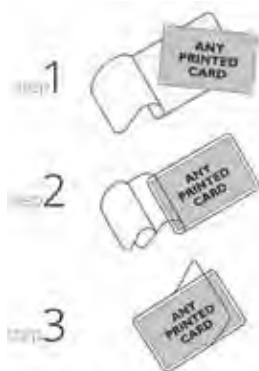

Size	Dimensions	Ref	Pack 100
Credit card	54x86mm	3801	£8.63
Business card	66x100mm	3805	£9.51
Business card long edge slot	100x66mm	3806	£14.02
Business card short edge slot	66x100mm	3804	£17.34
A7	86x117mm	3807	£13.32
A7	75x105mm	3808	£13.14
A6	117x160mm	3811	£26.04



HAVE YOU USED OUR WEBSITE?

The trade destination for offers, easy ordering and 1000s of finishing solutions. presco.eu

We'll **PRICE MATCH** or **BEAT**, speak to us now

RENZ LAMIGO POUCH LAMINATORS

A range of new Renz entry level laminators for pouch thicknesses up to 250mic. Ultra compact design in plastic and metal construction. Width up to 330mm / A3 and warm up time from cold is just 45 seconds and a laminating speed of 480mm per minute on the A3 Pro.

Product	Ref	Price
Renz Lamigo A4	0514	£92.45
Renz Lamigo A3	0513	£115.50
Renz Lamigo A3 Pro	0512	£161.80



RENZ LAMIGATOR PROFESSIONAL POUCH LAMINATORS

Strong, attractive and high-performance A3 pouch laminating machines in a metal-housing. Suitable for all types of laminating. The Lamigator IQ has intelligent functions: IQ auto run, IQ anti-jam, IQ power off. The IQ sensor detects the product to be laminated and sets itself automatically for a perfect laminating result. The Lamigator Speed is a high-speed laminating system for a range of applications. Numerous settings and the 6 rolls ensure perfect laminating results with impressive speed.

Product	Ref	Price
Renz Lamigator IQ A3 Pouch Laminator	0516	£369.00
Renz Lamigator Speed A3 Pouch Laminator	0517	£831.50



A2 POUCH LAMINATORS

The Professional A2 Laminator is a trade quality machine that will laminate all sizes of laminating pouches from credit card size right up to A2 posters. A best seller into schools and anywhere that wants to produce laminated posters as well as smaller work.

The High Speed A2 6 Roller Laminator is a market leading machine giving speed and quality at a great price. This machine can handle a vast variety of work from small badges through to A2 posters. It has a unique simple-to-use control panel with memory function. This is the machine for any one offering a top quality on-demand laminating service.

Product	Ref	Price
Professional A2 Laminator	0523	£315.00
High Speed A2 6 Roller Laminator	0529	£676.95



Mini ID Card Pouch Laminator
on page 98

ENCAPSULATION FILMS

These films vary from laminating films as they are always applied to both sides of the substrate at the same time.

The 75 micron to 250 micron films are much thicker than laminating films and there is more adhesive on them. In particular, the 125 micron and 250 micron films will stick successfully to almost any printed work (subject to testing first).



GUIDE TO ENCAPSULATION FILM ADHESIVE LEVELS

2

**PRESCO 42 MICRON
LIGHTWEIGHT FILM**

4

**PRESCO 75 MICRON
MEDIUM FILM**

6

**PRESCO 125 MICRON
HEAVY FILM**

8

**PRESCO 250 MICRON
VERY HEAVY FILM**

PRESCO 42 MICRON – LIGHTWEIGHT FILM

ADHESIVE
LEVEL

2

Used as an alternative to OPP laminating films if user only has this type of machine.

GLOSS 25MM CORE (1")

Width	Length	Thickness	Ref	Price
320mm	150m	42mic	11132	£17.80
455mm	150m	42mic	11145	£24.85
635mm	150m	42mic	11163	£34.25
685mm	150m	42mic	11168	£36.86

GLOSS 57MM CORE (2 1/4")

Width	Length	Thickness	Ref	Price
320mm	150m	42mic	12132	£17.80
455mm	150m	42mic	12145	£24.85
635mm	150m	42mic	12163	£34.25
685mm	150m	42mic	12168	£36.86

SATIN MATT 25MM CORE (1")

Width	Length	Thickness	Ref	Price
320mm	150m	42mic	11632	£29.95
455mm	150m	42mic	11645	£42.16
635mm	150m	42mic	11663	£58.47

SATIN MATT 57MM CORE (2 1/4")

Width	Length	Thickness	Ref	Price
320mm	150m	42mic	12632	£29.95
455mm	150m	42mic	12645	£42.16
635mm	150m	42mic	12663	£58.47

DEAD MATT 25MM CORE (1")

Width	Length	Thickness	Ref	Price
320mm	150m	42mic	11932	£42.66
455mm	150m	42mic	11945	£60.28

Longer rolls in any finish and more Dead Matt film options available to order. Call us for more details **01793 716300**.

PRESCO 75 MICRON – MEDIUM FILM

ADHESIVE
LEVEL

4

Thin but sturdy film widely used in education and for short-term use work.

GLOSS 25MM CORE (1")

Width	Length	Thickness	Ref	Price
320mm	100m	75mic	11232	£22.04
455mm	100m	75mic	11245	£30.78
635mm	100m	75mic	11263	£42.42
685mm	100m	75mic	11268	£45.65

GLOSS 57MM CORE (2 1/4")

Width	Length	Thickness	Ref	Price
320mm	100m	75mic	12232	£22.04
455mm	100m	75mic	12245	£30.78
635mm	100m	75mic	12263	£42.42
685mm	100m	75mic	12268	£45.65

SATIN MATT 25MM CORE (1")

Width	Length	Thickness	Ref	Price
320mm	100m	75mic	11732	£29.62
455mm	100m	75mic	11745	£41.71
635mm	100m	75mic	11763	£57.80

SATIN MATT 57MM CORE (2 1/4")

Width	Length	Thickness	Ref	Price
320mm	100m	75mic	12732	£29.62
455mm	100m	75mic	12745	£41.71
635mm	100m	75mic	12763	£57.80

DEAD MATT 25MM CORE (1")

Width	Length	Thickness	Ref	Price
320mm	100m	75mic	11934	£36.61
455mm	100m	75mic	11947	£51.68

Longer rolls in any finish and more
Dead Matt film options available to order.
Call us for more details **01793 716300**.



PRESCO 125 MICRON – HEAVY FILM

ADHESIVE
LEVEL

6

The most common film used for posters, POS work, marketing work and signage.

GLOSS 25MM CORE (1")

Width	Length	Thickness	Ref	Price
320mm	50m	125mic	11332	£19.02
455mm	50m	125mic	11345	£26.46
635mm	50m	125mic	11363	£36.34
685mm	50m	125mic	11368	£39.11

GLOSS 57MM CORE (2 1/4")

Width	Length	Thickness	Ref	Price
320mm	100m	125mic	12332	£36.61
455mm	100m	125mic	12345	£51.47
635mm	100m	125mic	12363	£71.26
685mm	100m	125mic	12368	£76.75

GLOSS 76MM CORE (3")

Width	Length	Thickness	Ref	Price
320mm	100m	125mic	6733	£30.78
455mm	100m	125mic	6735	£43.78
635mm	100m	125mic	6737	£61.10
914mm	100m	125mic	6740	£87.93
965mm	100m	125mic	6742	£92.85
1065mm	100m	125mic	6744	£93.15
1380mm	100m	125mic	6746	£106.77

We'll **PRICE MATCH** or **BEAT**, speak to us now

SATIN MATT 25MM CORE (1")

Width	Length	Thickness	Ref	Price
320mm	50m	125mic	11432	£22.63
455mm	50m	125mic	11445	£35.29
635mm	50m	125mic	11463	£48.81

SATIN MATT 57MM CORE (2 1/4")

Width	Length	Thickness	Ref	Price
320mm	50m	125mic	12432	£22.63
455mm	50m	125mic	12445	£35.29
635mm	50m	125mic	12463	£48.81

SATIN MATT 76MM CORE (3")

Width	Length	Thickness	Ref	Price
320mm	100m	125mic	6734	£50.31
455mm	100m	125mic	6736	£71.54
635mm	100m	125mic	6738	£99.84
914mm	100m	125mic	6741	£143.69
965mm	100m	125mic	6743	£144.98
1065mm	100m	125mic	6745	£167.44
1380mm	100m	125mic	6747	£186.60

Order online 24/7 for
FAST delivery [presco.eu](https://www.presco.eu)

DEAD MATT 25MM CORE (1")

Width	Length	Thickness	Ref	Price
320mm	50m	125mic	11936	£23.90
455mm	50m	125mic	11949	£33.60



PRESCO 250 MICRON – VERY HEAVY FILM

ADHESIVE
LEVEL

8

A semi-rigid material for very heavy duty work, for signs/display work and rigid cards such as membership and instruction cards.

GLOSS 25MM CORE (1")

Width	Length	Thickness	Ref	Price
320mm	25m	250mic	11532	£16.83
455mm	25m	250mic	11545	£23.46
635mm	25m	250mic	11563	£32.31
685mm	25m	250mic	11568	£34.76

GLOSS 57MM CORE (2^{1/4"})

Width	Length	Thickness	Ref	Price
320mm	50m	250mic	12532	£32.54
455mm	50m	250mic	12545	£45.81
635mm	50m	250mic	12563	£63.51
685mm	50m	250mic	12568	£68.41

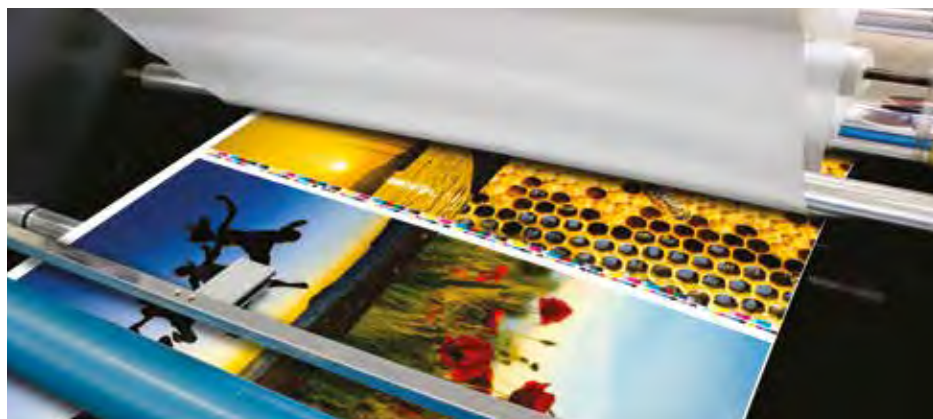

SPECIALS

Our specials department can manufacture or source any custom product for you, give us a call on **01793 716300**.

+much,
much more!
See pages
56-57

Some of our most popular specials are:

- Bespoke size pockets
- Custom elastic loops and cord
- Literature dispensers
- Hook & loop cut lengths
- Specialist tapes
- Printed lanyards
- POS fixings and fittings

Custom widths,
colour, paired
and cut to length

hook & loop



Printed
Lanyards

BINDING WIRES

SPOOLS – CUT LENGTHS – MACHINES

**PRESCO TRADE
BINDING WIRES**

Presco page 20

premium+

BINDING WIRES

Presco page 22

**RENZ
BINDING WIRES**

page 26

NEW

**PRESCO
PROFESSIONAL
SPOOLS**

page 24

**RENZ
WIRE SPOOLS**

page 28

**MORE BINDING
SUPPLIES**

COMBS page 32
COILS page 33
COVERS page 34
PRESENTATION
BINDERS page 35

**BINDING
MACHINES**

page 30

PRESCO TRADE BINDING WIRES

Bulk pack sizes of economy binding wires for maximum value

PRESCO 3:1 PITCH BINDING WIRES

Wire no.	Max no. of 80gsm sheets	Diam.	Diam.	Max. book thickness	Box quantity
4	48	6.9mm	1/4"	4.8mm	250
5	64	8mm	5/16"	6.4mm	250
6	79	9.5mm	3/8"	7.9mm	250
7	95	11mm	7/16"	9.5mm	250
8	111	12.7mm	1/2"	11.1mm	250
9	127	14.3mm	9/16"	12.7mm	250

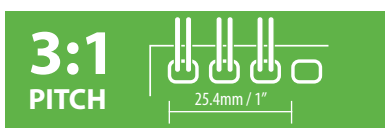

Available in four standard colours:

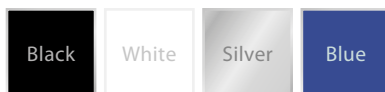

A4 CUT LENGTHS (34 LOOPS)



Wire no.	Black	White	Silver	Blue	Price	Price 8+	Price 16+
4	2040	2041	2048	2042	£10.39	£9.36	£8.84
5	2050	2051	2058	2052	£12.60	£11.34	£10.71
6	2060	2061	2068	2062	£14.79	£13.31	£12.57
7	2070	2071	2078	2072	£19.56	£17.61	£16.63
8	2080	2081	2088	2082	£21.65	£19.48	£18.40
9	2090	2091	2098	2092	£26.84	£24.16	£22.82

A5 CUT LENGTHS (24 LOOPS)

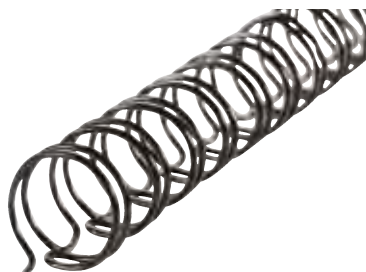

Wire no.	Black	White	Silver	Blue	Price	Price 8+	Price 16+
4	2240	2241	2248	2242	£10.06	£9.05	£8.55
5	2250	2251	2258	2252	£11.56	£10.40	£9.82
6	2260	2261	2268	2262	£13.40	£12.06	£11.39
7	2270	2271	2278	2272	£15.18	£13.66	£12.90
8	2280	2281	2288	2282	£16.99	£15.29	£14.45
9	2290	2291	2298	2292	£23.15	£20.83	£19.68

PRESCO 2:1 PITCH BINDING WIRES

Wire no.	Max no. of 80gsm sheets	Diam.	Diam.	Max. book thickness	Box quantity
10	143	16mm	5/8"	14.3mm	200
12	175	19mm	3/4"	17.5mm	200
14	206	22mm	7/8"	20.6mm	200
16	238	25.4mm	1"	23.8mm	200
20	280	32mm	1 1/4"	28mm	125

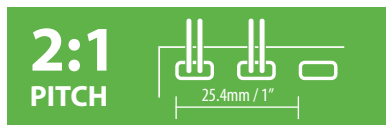

Available in three standard colours:

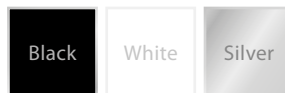

A4 CUT LENGTHS (23 LOOPS)

Wire no.	Black	White	Silver	Price	Price 8+	Price 16+
10	2100	2101	2108	£20.44	£18.40	£17.37
12	2110	2111	2118	£24.98	£22.48	£21.23
14	2120	2121	2128	£32.60	£29.34	£27.71
16	2130	2131	2138	£36.83	£33.15	£31.30
20	2140	2141	2148	£56.67	£51.01	£48.17



A5 CUT LENGTHS (16 LOOPS)

Wire no.	Black	White	Silver	Price	Price 8+	Price 16+
10	2300	2301	2308	£18.55	£16.70	£15.77
12	2310	2311	2318	£20.63	£18.56	£17.53
14	2320	2321	2328	£24.42	£21.97	£20.75
16	2330	2331	2338	£26.78	£24.10	£22.76
20	2340	2341	2348	£43.22	£38.90	£36.74

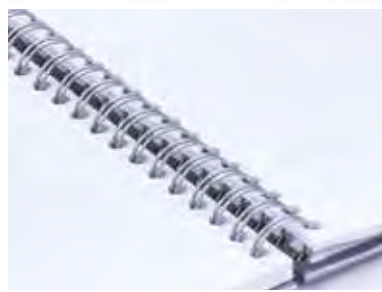

We'll **PRICE MATCH** or **BEAT**, speak to us now

PREMIUM BINDING WIRES

Premium quality wires in
handy pack sizes

Presco✓

premium+
BINDING WIRES

NEW
RANGE

PRESCO 3:1 PITCH BINDING WIRES

3:1
PITCH

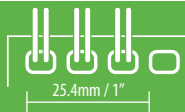

Available in four standard colours:

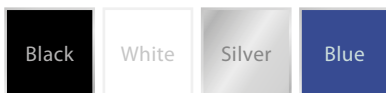

Wire no.	Max no. of 80gsm sheets	Diam.	Diam.	Max. book thickness	Box quantity
3	25	5.5mm	3/16"	2.5mm	100
4	48	6.9mm	1/4"	4.8mm	100
5	64	8mm	5/16"	6.4mm	100
6	79	9.5mm	3/8"	7.9mm	100
7	95	11mm	7/16"	9.5mm	100
8	111	12.7mm	1/2"	11.1mm	100
9	127	14.3mm	9/16"	12.7mm	100
10	143	16mm	5/8"	14.3mm	50

A4 CUT LENGTHS (34 LOOPS)

Wire no.	Black	White	Silver	Blue	Price	Price 10+
3	48030	48031	48038	48032	£8.93	£7.59
4	48040	48041	48048	48042	£9.49	£8.07
5	48050	48051	48058	48052	£12.56	£10.67
6	48060	48061	48068	48062	£13.84	£11.76
7	48070	48071	48078	48072	£16.87	£14.34
8	48080	48081	48088	48082	£18.53	£15.75
9	48090	48091	48098	48092	£24.00	£20.40
10	48000	48001	48008	48002	£14.87	£12.64

A5 CUT LENGTHS (24 LOOPS)

Wire no.	Black	White	Silver	Blue	Price	Price 10+
3	48230	48231	48238	48232	£7.62	£6.48
4	48240	48241	48248	48242	£7.99	£6.79
5	48250	48251	48258	48252	£10.62	£9.03
6	48260	48261	48268	48262	£11.79	£10.02
7	48270	48271	48278	48272	£14.31	£12.16
8	48280	48281	48288	48282	£15.20	£12.92
9	48290	48291	48298	48292	£18.83	£16.01
10	48200	48201	48208	48202	£12.28	£10.44



NEW RANGE

PRESCO 2:1 PITCH BINDING WIRES

**2:1
PITCH**

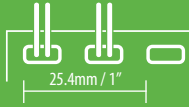

Available in three standard colours:



Wire no.	Max no. of 80gsm sheets	Diam.	Diam.	Max. book thickness	Box quantity
4	48	6.9mm	1/4"	4.8mm	100
5	64	8mm	5/16"	6.4mm	100
6	79	9.5mm	3/8"	7.9mm	100
7	95	11mm	7/16"	9.5mm	100
8	111	12.7mm	1/2"	11.1mm	100
9	127	14.3mm	9/16"	12.7mm	100
10	143	16mm	5/8"	14.3mm	50
12	175	19mm	3/4"	17.5mm	50
14	206	22mm	7/8"	20.6mm	50
16	238	25.4mm	1"	23.8mm	50
20	280	32mm	1 1/4"	28mm	50
24	300	38mm	1 1/2"	32.2mm	20

A4 CUT LENGTHS (23 LOOPS)

Wire no.	Black	White	Silver	Price	Price 10+
4	48440	48441	48448	£9.11	£7.74
5	48450	48451	48458	£12.56	£10.67
6	48460	48461	48468	£13.56	£11.53
7	48470	48471	48478	£16.54	£14.06
8	48480	48481	48488	£17.76	£15.10
9	48490	48491	48498	£23.08	£19.61
10	48100	48101	48108	£13.49	£11.47
12	48110	48111	48118	£16.30	£13.86
14	48120	48121	48128	£19.32	£16.42
16	48130	48131	48138	£22.80	£19.38
20	48140	48141	48148	£40.64	£34.55
24	48150	48151	48158	£24.93	£21.19

A5 CUT LENGTHS (16 LOOPS)

Wire no.	Black	White	Silver	Price	Price 10+
4	48540	48541	48548	£7.29	£6.20
5	48550	48551	48558	£9.61	£8.17
6	48560	48561	48568	£9.90	£8.42
7	48570	48571	48578	£13.06	£11.10
8	48580	48581	48588	£13.94	£11.85
9	48590	48591	48598	£17.33	£14.73
10	48300	48301	48308	£10.68	£9.08
12	48310	48311	48318	£12.96	£11.02
14	48320	48321	48328	£15.54	£13.21
16	48330	48331	48338	£17.34	£14.74
20	48340	48341	48348	£31.09	£26.43
24	48350	48351	48358	£19.44	£16.52



PRESCO BINDING WIRE SPOOLS

Professional trade spools with premium quality wire

VOLUME USER?

contact us for the best prices



Contact us on 01793 716300 to get set up with special trade pricing on our spools now

PRESCO BINDING WIRE SPOOLS 3:1

Wire no.	Loops	Diam.	Black	White	Silver	Price	Price 12+
4	93,000	6.9mm	2740	2741	2748	£105.24	£89.45
5	66,000	8mm	2750	2751	2758	£103.98	£88.38
6	47,000	9.5mm	2760	2761	2768	£84.92	£72.18
7	34,000	11mm	2770	2771	2778	£83.12	£70.65
8	26,000	12.7mm	2780	2781	2788	£72.14	£61.32
9	21,000	14.3mm	2790	2791	2798	£79.89	£67.91
10	15,000	16mm	2800	2801	2008	£73.45	£62.43

3:1 PITCH

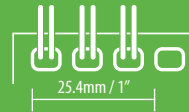

Stocked in three standard colours:



New colours available to order including Rose Gold - ask for details



PRESCO BINDING WIRE SPOOLS

Presco wire binding spools are formed from the highest quality wire and have got top ratings from the most demanding users. The sides are more rigid than other brands and this also improves productivity.

Spools are available in both 2:1 and 3:1 pitches and in black, white and silver. Our Presco premium quality wire spools offer excellent value. These spools have been tested on many different automatic wire binding machines with outstanding results.



PRESCO BINDING WIRE SPOOLS 2:1

Wire no.	Loops	Diam.	Black	White	Silver	Price	Price 12+
10	10,500	16mm	1900	1901	1908	£71.76	£61.00
12	8,000	19mm	1910	1911	1918	£66.87	£56.84
14	6,000	22mm	1920	1921	1928	£62.30	£52.95
16	4,000	25.4mm	1930	1931	1938	£51.77	£44.00

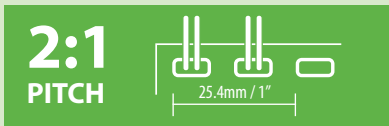

Stocked in three standard colours:

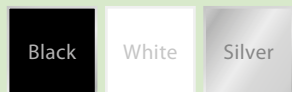

New colours available to order including Rose Gold - ask for details

RENZ BINDING WIRES

RENZ 3:1 PITCH BINDING WIRES

Wire no.	Diameter	Diameter	Max. book thickness	Max. no. 80gsm sheets
3	5.5mm	3/16"	2.5mm	25
4	6.9mm	1/4"	4.8mm	48
5	8.0mm	5/16"	6.4mm	64
6	9.5mm	3/8"	7.9mm	79
7	11.0mm	7/16"	9.5mm	95
8	12.7mm	1/2"	11.1mm	111
9	14.3mm	9/16"	12.7mm	127
10	16mm	5/8"	14.3mm	143



A4 CUT LENGTHS (34 LOOPS)

Wire no.	Box size	Black	White	Blue	Red	Green	Bronze	Silver	Price
3	100	8030	8031	8032	8033	8034	8036	8038	£10.00
4	100	8040	8041	8042	8043	8044	8046	8048	£10.60
5	100	8050	8051	8052	8053	8054	8056	8058	£14.44
6	100	8060	8061	8062	8063	8064	8066	8068	£15.62
7	100	8070	8071	8072	8073	8074	8076	8078	£18.90
8	100	8080	8081	8082	8083	8084	8086	8088	£20.74
9	50	8090	8091	8092	8093	8094	8096	8098	£13.10
10	50	8000	8001	8002	8003	8004	8006	8008	£16.72

A5 CUT LENGTHS (24 LOOPS)

Wire no.	Box size	Black	White	Blue	Red	Green	Bronze	Silver	Price
3	100	8230	8231	8232	8233	8234	8236	8238	£8.63
4	100	8240	8241	8242	8243	8244	8246	8248	£9.15
5	100	8250	8251	8252	8253	8254	8256	8258	£12.46
6	100	8260	8261	8262	8263	8264	8266	8268	£13.49
7	100	8270	8271	8272	8273	8274	8276	8278	£15.92
8	100	8280	8281	8282	8283	8284	8286	8288	£17.49
9	50	8290	8291	8292	8293	8294	8296	8298	£10.83
10	50	8200	8201	8202	8203	8204	8206	8208	£13.75

Cut lengths available in seven standard colours:

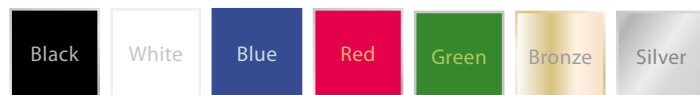

The easy-use binding wires, each individually packaged on carboard trays. Perfect quality with a big range of colours and sizes. We're the largest UK stockist of Renz binding wires, purchase by 4pm, with you tomorrow.

RENZ 2:1 PITCH BINDING WIRES

Wire no.	Diameter	Diameter	Max. book thickness	Max. no. 80gsm sheets
4	6.9mm	1/4"	4.8mm	48
5	8mm	5/16"	6.4mm	64
6	9.5mm	3/8"	7.9mm	79
7	11mm	7/16"	9.5mm	95
8	12.7mm	1/2"	11.1mm	111
9	14.3mm	9/16"	12.7mm	127
10	16mm	5/8"	14.3mm	143
12	19mm	3/4"	17.5mm	165
14	22mm	7/8"	20.6mm	195
16	25.4mm	1"	23.8mm	225
20	32mm	1 1/4"	28mm	265
24	38mm	1 1/2"	32.2mm	300

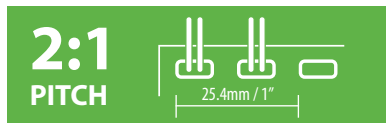

A4 CUT LENGTHS (23 LOOPS)

Wire no.	Box size	Black	White	Silver	Blue	Price
4	100	8440	8441	8448	8442	£10.15
5	100	8450	8451	8458	8452	£14.03
6	100	8460	8461	8468	8462	£15.03
7	100	8470	8471	8478	8472	£18.38
8	100	8480	8481	8488	8482	£19.82
9	50	8490	8491	8498	8492	£13.10
10	50	8100	8101	8108	8102	£15.38
12	50	8110	8111	8118	8112	£18.21
14	50	8120	8121	8128	8122	£22.10
16	50	8130	8131	8138	8132	£25.38
20	25	8140	8141	8148	8142	£22.31
24	20	8150	8151	8158	8152	£26.64

A5 CUT LENGTHS (16 LOOPS)

Wire no.	Box size	Black	White	Silver	Price
4	100	8540	8541	8548	£8.23
5	100	8550	8551	8558	£11.23
6	100	8560	8561	8568	£11.23
7	100	8570	8571	8578	£14.62
8	100	8580	8581	8588	£15.72
9	50	8590	8591	8598	£9.55
10	50	8300	8301	8308	£12.28
12	50	8310	8311	8318	£14.51
14	50	8320	8321	8328	£17.54
16	50	8330	8331	8338	£20.10
20	25	8340	8341	8348	£17.69
24	20	8350	8351	8358	£21.05

Cut lengths available in four standard colours:

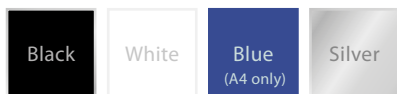

RENZ BINDING WIRE SPOOLS

RENZ 3:1 WIRE ON SPOOLS

Wire no.	Loops per spool	Size	Black	White	Silver	Price	Price 4+
3	127,000	3/16"	8730	8731	8738	£248.00	£229.40
4	91,000	1/4"	8740	8741	8748	£190.15	£175.89
5	64,000	5/16"	8750	8751	8758	£183.46	£169.70
6	46,000	3/8"	8760	8761	8768	£143.50	£132.74
7	34,000	7/16"	8770	8771	8778	£128.56	£118.92
8	26,000	1/2"	8780	8781	8788	£108.68	£100.53
9	21,500	9/16"	8790	8791	8798	£109.18	£100.99
10	15,000	5/8"	8800	8801	8808	£99.28	£91.83



2:1 spools available, please contact us to order

RENZ RING WIRE OPENER

A great new product for un-binding a wire bound document without damaging the pages. Simply slide the tool through the wire and it will open the wire so pages can be changed or added.



Product	Ref	Price
Wire opener	0689	£19.00

IBIWIRES

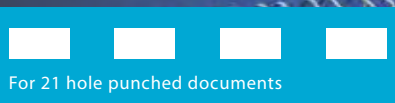

Diameter	Max. no. 80gsm sheets	Black	White	Silver	Price
6mm	20	3710	3711	3718	£21.34
8mm	45	3720	3721	3728	£22.52
10mm	65	3730	3731	3738	£28.60
12mm	100	3740	3741	3748	£36.04
14mm	120	3750	3751	3758	£36.36

Ibiwire binding wires are a niche form of wire binding. They are spaced to fit the punched hole usually used for plastic comb binding. The holes can be punched with any plastic comb binding machine, but a separate wire closer is needed. There are very few comb binding machines that incorporate a wire closer. Ibiwire hole spacing is exactly the same as for A4 21 ring combs. A4 Ibiwires have 21 loops. Pack size 100.

CALENDAR BINDING PACKAGES



See how to make a calendar!  go to presco.eu/cal



CALENDAR KIT 1 INCLUDES:

1. Calendar Thumbcut Punch with guides & 6mm round-cornering die
2. Wire Cutters
3. 1,000 Calendar Wire Hangers
4. 4 x 250 packs of No. 4 size A4 or A5 Binding Wires

£149
save £40+



CALENDAR KIT 2 INCLUDES:

1. Renz SRW Premium trade wire binding machine
2. Calendar Thumbcut Punch with guides & 6mm round-cornering die
3. Wire cutters
4. 4 x 250 packs of No. 4 size A4 or A5 Binding Wires
5. 1,000 Calendar Wire Hangers

£599
save £150+



CALENDAR KIT 3 INCLUDES: NEW!

1. Renz SRW 360 Comfortplus Fast Electric Binding Machine
2. Calendar Thumbcut Punch
3. Wire Cutters
4. 2,000 No. 4 A4 or A5 Binding Wires
5. 2,000 Calendar Wire Hangers

£1,799
save £300+

For more details call us now on 01793 716300

BINDING MACHINES

RENZ SRW 360 3:1 WIRE BINDER

This is our most popular 3:1 trade wire binder. It punches up to 25 sheets of 80gsm paper in one go and, thanks to its selectable pins, it will also punch non-standard paper sizes up to 360mm in length. The SRW 360 will bind from 2.5mm up to 16mm thick using wire numbers 3 to 10 and has an adjustable margin depth.



To see more machines, information and videos visit presco.eu

Product	Ref	Price
SRW 360	0614	£554.00



Top Renz quality from presco for over 25 years.

We guarantee best prices on all renz punch and binding machines, speak to us on **01793 716300**.

RENZ ECO-S 360 2:1 WIRE BINDER

With all of the same features as the SRW 360, the Eco S is the 2:1 version and punches up to 25 sheets of 80gsm in one go. It can bind all sizes up to 32mm thickness using 2:1 pitch wires.

Product	Ref	Price
ECO-S	0649	£554.00

RENZ DTP 340-A SEMI-AUTO PUNCHING SYSTEM

The Renz DTP 340 A brings us into the realms of production quantity wire binding!

- Revolutionary machine that dramatically increases punching speed without the massive price of automatic punching equipment.
- Punches 35 sheets at a time.
- Takes a wide range of punching dies for binding systems.
- Operator just inserts paper and machine automatically punches and stacks.

Product	Ref	Price
DTP 340-A	0680	Call us

DTP 340-A Die Tools	Ref	Price
Plastic Coil Binding	0679.1	£1,105.38
Plastic Comb Binding	0681.1	£874.13
2:1 Wire - Round Hole	0682.R	£874.13
2:1 Wire - Square Hole	0682.S	£874.13
3:1 Wire - Round Hole	0683.R	£874.13
3:1 Wire - Square Hole	0683.S	£874.13
3:1 Wire + Cal. Thumbcut	0684.1	£1,197.88

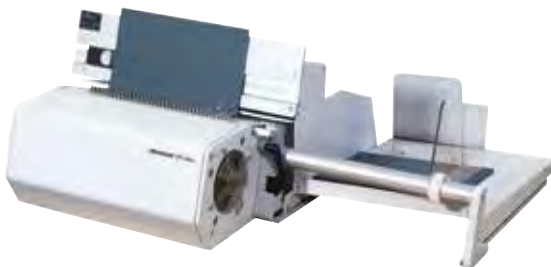

RENZ ELECTRIC MACHINES

RENZ SRW 360 COMFORTPLUS ELECTRIC WIRE BINDER

3:1 pitch electric punching and manual binding machine designed for regular use in a small to medium sized office. This machine can now achieve a punching capacity of 14,000 sheets per hour, increasing productivity and reducing time.

Product	Ref	Price
SRW 360 Comfortplus	0613	Call us



RENZ ECO 360 COMFORTPLUS 2:1 WIRE BINDER

A considerably improved punching speed compared with the older Eco comfort machines. This machine has twice the punching speed of the previous model and is capable of punching 14,000 sheets of 80 gram paper per hour.

Product	Ref	Price
Eco 360 Comfortplus	0624	Call us



RENZ ECL 360 ELECTRIC WIRE CLOSER

The ideal companion to electric punching models, the ECL 360 can quickly and easily close wires of any pitch up to a width of 360mm. Its micro-adjustment capabilities also make it the perfect tool for all types and qualities of wire. 500mm and 700mm width versions are also available.

Product	Ref	Price
ECL 360	0625	Call us



RENZ DTP 340-M PUNCH SYSTEM

This is a highly flexible, heavy duty punch for up to 35 80gsm sheets at once. Different interchangeable dies available which can be swapped around quickly. Speak to us for more details and pricing.

Product	Ref	Price
DTP 340-M Machine	0600	Call us



We'll PRICE MATCH or BEAT, speak to us now

DTP 340-M Die Tools	Ref	Price
Plastic Coil Binding	0605.1	£1,105.37
Plastic Comb Binding	0601.1	£874.13
2:1 Wire - Oblong Hole	0602.0	£874.13
2:1 Wire - Round Hole	0602.R	£874.13
2:1 Wire - Square Hole	0602.S	£874.13
3:1 Wire - Round Hole	0603.R	£874.13
3:1 Wire - Square Hole	0603.S	£874.13
3:1 Wire + Cal. Thumbcut	0604.S	£1,197.85

BINDING COMBS

PLASTIC BINDING COMBS

Plastic Comb binding is practical, low cost and less likely to crush. One of the big advantages of the comb binding system is the ability to reopen the document to add or remove pages at any time in the future. The binding capacity of up to 50mm exceeds most other binding systems.



ROUND 21 RING COMBS

Diam.	Max. book thickness	Max no. of 80gms sheets	Box quantity	Black	White	Blue	Green	Red	Price
6mm	3mm	30	100	2520	2521	2522	2524	2523	£2.84
8mm	5mm	45	100	2530	2531	2532	2534	2533	£3.40
10mm	7mm	65	100	2540	2541	2542	2544	2543	£3.97
12mm	10mm	95	100	2550	2551	2552	2554	2553	£5.69
14mm	12mm	115	100	2560	2561	2562	2564	2563	£6.77
16mm	14mm	135	100	2570	2571	2572	2574	2573	£8.29
19mm	17mm	160	100	2580	2581	2582	2584	2583	£9.80
22mm	20mm	190	50	2590	2591	2592	2594	2593	£6.91
25mm	23mm	220	50	2610	2611	2612	2614	2613	£8.20
28mm	26mm	240	50	2620	2621	2622	2624	2623	£9.66
32mm	31mm	300	50	2650	2651	2652	2654	2653	£9.71
38mm	37mm	350	50	2660	2661	2662	2664	2663	£10.91
45mm	44mm	430	50	2670	2671	2672	2674	2673	£11.91
51mm	50mm	475	50	2680	2681	2682	2684	2683	£13.50

OVAL 21 RING COMBS

PLASTIC COMB BINDING MACHINES

RENZ COMBI BINDERS



The Combinette is our entry level comb binder and is a no nonsense, high quality manual machine. It will punch up to 25 sheets of 80gsm at a time and is specifically for A4 documents.

Product	Ref	Price
Combinette	0641	£415.30
Combi S	0645	£507.80
Combi Comfortplus	0644	Call us

The Combi S has the flexibility to punch and bind A4, A5 and non-standard sized documents, it is our most popular comb binder. Able to punch up to 25 sheets in one go and with an adjustable margin depth.

The Combi Comfortplus has a powerful punching motor with an output of 16,000 sheets per hour. It's an excellent machine for regular use in a low to medium volume print room.

PLASTIC COILS

Plastic coils are an attractive and virtually indestructible binding method – ideal for heavy use and documents being posted. We can supply many other colours and sizes in addition to those below. The pitch ratio for these coils is 4:1.



A4 PRODUCT CODES

<i>Diam.</i>	<i>Max no. of 80gsm sheets</i>	<i>Box quantity</i>	<i>Black</i>	<i>White</i>	<i>Clear</i>	<i>Price</i>
6mm	31	100	2810	2811	2819	£6.29
8mm	46	100	2820	2821	2829	£7.82
10mm	70	100	2830	2831	2839	£9.95
12mm	86	100	2840	2841	2849	£12.00
14mm	109	100	2850	2851	2859	£13.15
16mm	125	100	2860	2861	2869	£20.00
18mm	140	100	2870	2871	2879	£28.90
20mm	156	100	2880	2881	2889	£31.37
22mm	175	100	2890	2891	2899	£32.53
25mm	195	100	2900	2901	2909	£38.87

A5 PRODUCT CODES

<i>Black</i>	<i>White</i>	<i>Clear</i>	<i>Price</i>
3210	3211	3219	£6.47
3220	3221	3229	£8.00
3230	3231	3239	£9.72
3240	3241	3249	£11.58
3250	3251	3259	£13.61
3260	3261	3269	£15.83
3270	3271	3279	£24.02
3280	3281	3289	£25.94

SPB 360 PLASTIC COIL BINDING MACHINE

The Renz SPB 360 is a brilliant coil binding system which incorporates a manual punch for up to 18 sheets and an electric inserter, enabling you to make documents up to a massive 195 sheets (18mm) thick. You can also upgrade the punch to electric with a simple plug-in device – call for details.

<i>Product</i>	<i>Ref</i>	<i>Price</i>
SPB 360	0670	Call us
Manual Crimping Pliers	0914	£25.96



BINDING COVERS & FOLDERS

PLASTIC BINDING COVERS / ACETATES

The PVC covers are the most common covers used for binding. When binding with a system using heat, such as fastback, the heat-resistant Polyester covers should be used. The thicker 500 micron Polypropylene covers have a soft embossed surface and give a luxury touch.



Size	Thickness/Type	Material type	Ref	Pack 100	Pack 1000
A5	140mic/clear	PVC	1626	£3.66	£28.58
A4	140mic/clear	PVC	1634	£5.43	£44.24
A3	140mic/clear	PVC	1637	£16.86	-
A4	175mic/clear	Polyester	1620	£29.87	-
A5	230mic/clear	PVC	1627	£6.95	£47.61
A4	230mic/clear	PVC	1625	£8.89	£73.00
A3	230mic/clear	PVC	1639	£20.41	-
A5	450mic/frosted	Polypropylene	1611	£9.63	-
A4	450mic/frosted	Polypropylene	1610	£17.81	£117.30
A3	450mic/frosted	Polypropylene	1608	£33.25	-
A4	700mic/frosted	Polypropylene	1616	£13.49	pack of 50

PRE-PUNCHED PLASTIC BINDING COVERS

These PVC covers are pre-punched for wire and plastic comb binding. A popular choice as they eliminate wear and jamming when punching plastic covers. All covers are fully transparent.



Size	Thickness	Punched for	Ref	Pack 100
A4	240mic	21 ring comb	1603	£15.55
A4	240mic	20 ring comb	1604	£15.55
A4	240mic	3:1 wire	1606	£15.55
A4	240mic	2:1 wire	1605	£17.26

CARD BINDING COVERS

A range of gloss card and leathergrain card binding covers. Our A4 metallic silver covers (also known as Chromulux covers) are thick card covers with an attractive silver coating on one side and plain white on the reverse. All exact A4 or A3 sizes.



Size / type	Black	White	Light Blue	Royal Blue	Red	Dark Green	Silver	Pack 100
A4 Gloss	-	1681	-	-	-	-	-	£8.98
A3 Gloss	-	1678	-	-	-	-	-	£20.17
A4 Leather-grain	1700	1701	1712	1702	1703	1704	-	£11.14
A4 Metallic	-	-	-	-	-	-	1688	£18.22

PRESCO TAB DIVIDERS

Type	Ref	Pack 10	100+ per 10
1-5 Printed Numbered Tabs	1805	£7.33	£4.77
1-10 Printed Numbered Tabs	1810	£13.00	£8.45
1-10 Plain Tabs	1850	£16.00	£10.40
1-15 Printed Numbered Tabs	1815	£18.67	£12.13
1-20 Printed Numbered Tabs	1820	£24.33	£15.82
1-25 Printed Numbered Tabs	1825	£30.00	£19.50
1-31 Printed Numbered Tabs	1831	£39.43	£25.63

Durable tab divider sets with laminated tabs to ensure maximum lifespan. All sets supplied unpunched in A4 size plus 13mm tab. Pack of 10 sets.

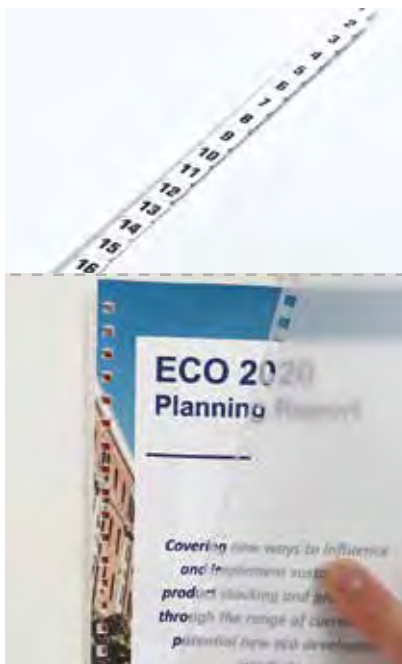

PLASTIC-FREE A4 BINDING COVERS ECO FROSTED EFFECT

Plastic-free eco A4 binding covers replace plastic binding covers for a fully paper recyclable bound document. Strong and semi-rigid material that is 0.2mm thick with a 200gsm weight and construction of the covers is a unbleached, totally chlorine free paper pulp, 100% recyclable, compostable and biodegradable.

Size	Ref	Pack 100	Pack 1000
A4	1612	£18.75	£158.00

PRESENTATION RING BINDERS

Premium presentation ring binders with a clear pocket at the front and spine to slide in pre-printed material.

Type	Max no. of 80gsm sheets	Ring diameter	Colour	Ref	Pack 10	100+ per 10
4 D Ring	80	15mm	White	1411	£14.51	£13.06
4 D Ring	180	25mm	White	1421	£14.17	£12.75
4 D Ring	330	40mm	White	1441	£16.27	£14.64
4 D Ring	430	50mm	White	1451	£18.26	£16.43
4 D Ring	580	65mm	White	1461	£24.93	£22.44
2 D Ring	180	25mm	White	1491	£13.62	£12.25
2 D Ring	180 (A5)	25mm	White	1493	£11.15	£10.03
4 D Ring	180	25mm	Black	1420	£14.51	£13.06
4 D Ring	330	40mm	Black	1440	£16.27	£14.64
2 D Ring	180	25mm	Black	1490	£13.62	£12.25



LEVER ARCH RING BINDER

Type	Ring diam.	Black	White	Price
2 D Ring	38mm	1530	1531	£18.47
2 D Ring	58mm	1550	1551	£19.26

Premium quality lever arch binders. They have a full size pocket on the outside front cover and the spine.



RING MECHANISMS

Type	Ring diam.	Pack size	Ref	Price
4 D Ring	15mm	250	1501	£115.52
4 D Ring	25mm	210	1502	£122.76
4 D Ring	40mm	125	1505	£106.50
4 D Ring	50mm	90	1507	£125.66
4 D Ring	65mm	72	1509	£108.36



A4 length mechanisms for the ring binders for fitting into custom made folders. They are also often used in point-of-sale displays where a catalogue is displayed in a retail or trade counter setting.

BINDING AND FILING POCKETS

Type	Size	Ref	Pack 100	Pack 1000
Binding/Filing Pocket 50mic	A5 plus margin	6941	£11.06	£71.88
Binding/Filing Pocket 50mic	A4 plus margin	6940	£11.30	£73.43
Binding Pocket Unpunched	A5 plus margin	6949	£38.37	£249.39
Binding Pocket Unpunched	A4 plus margin	6947	£41.84	£295.98
Binding Pocket Unpunched	A4 Overall	6946	£44.18	£287.14

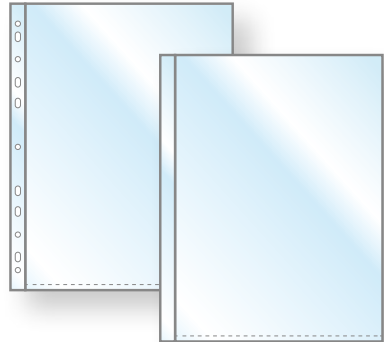

Clear plastic pockets for binding and filing, ranging from stationery quality multi-punched pockets (filing pockets are 50 microns) to our distinctive presentation quality binding pockets in heavy 140 micron material. Premium heavy quality pockets have 11mm unpunched margin to suit any punched binding system.

SPECIALS

Our specials department can manufacture or source any custom product for you, give us a call on **01793 716300**.

Some of our most popular specials are:

- Bespoke size pockets
- Custom elastic loops and cord
- Literature dispensers
- Hook & loop cut lengths
- Specialist tapes
- Printed lanyards
- POS fixings and fittings

+much,
much more!
See pages
56-57

FASTBACK STRIPS

Compatible model	Size	Max no. of 80gsm sheets	Black	White	Dark Blue	Pack 100
Fastback 15/20	Narrow	125 sheets	5300	5301	5302	£45.77
Fastback 15/20	Medium	250 sheets	5320	5321	5322	£57.52
Fastback 9	Narrow	125 sheets	5360	5361	-	£45.00

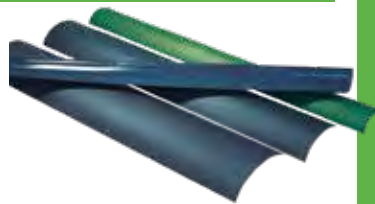

MEDICAL FILING CLIPS WHITE

Plastic filing clip system, traditionally used for large medical record files, a simple plastic alternative to

a lever arch file, reducing the bulk of square folders. 3 part non adhesive fixing with a flexible plastic tube (lace) and can be reused where needed.

Product	Ref	Pack 100	Pack 1000
Plastic filing clip system	7298	£17.95	£107.56



FILING PRONGS & COVER STRIPS

Filing prong sets for simple production of binders. The adhesive and white non-adhesive versions can be used alone or the cover strips slide over them to give a smarter finish.

Product	Ref	Pack 100	Pack 1000
Non-adhesive	7293	£11.32	£74.82
Adhesive filing prongs	7295	£26.93	£128.30
Plastic coated filing prongs	7294	£15.03	£100.74
A4 Cover strip	7290	£19.58	£89.87



ADHESIVE FILE STRIPS

Invaluable method to file magazines, leaflets or other printed work without punching the document. These strips have one edge multi-punched for use with most filing systems and the other edge is adhesive.

Size in mm	Ref	Pack 100	Pack 1000
A4	2460	£12.24	£91.39



TRADITIONAL METAL FILING CLIPS

Traditional bright metal two part filing clips sets.

Product	Ref	Pack 100	Pack 1000
Metal filing clips	7284	£20.87	£123.72



CALENDAR MAKING SUPPLIES

CALENDAR SLIDING WINDOW

The clear plastic straps wrap round the calendar and are linked with an elastic tag at the back. The red window, size 20 x 30mm, slides on the clear strips to mark the date. Supplied as a set of window, straps and elasticated tags to fit calendar widths of 210mm, 297mm and 420mm.

Calendar width	Ref	Pack 100	Pack 1000
210mm	2454	£33.53	£254.37
297mm	2455	£38.83	£344.46
420mm	2456	£43.80	£367.60



CALENDAR HANGERS

Length	Black	White	Blue	Red	Green	Bronze	Silver	Pack 100	Pack 1000
57mm	2410	2411	2412	2413	2414	2416	2418	£8.11	£29.29
76mm	2420	2421	2422	2423	2424	2426	2428	£8.54	£33.61
102mm	2430	2431	-	-	-	-	2438	£9.84	£35.96

57mm hangers are the most commonly used hangers and should be used when the hanger is inserted after binding the calendar. The 76mm and 102mm hangers give greater rigidity to the top edge of the calendar and these need to be inserted during the binding process.



Calendar binding in action  go to presco.eu/cal

For kits see page 29

WIRE CUTTERS

A handy pair of wire cutters used for cutting wire to custom lengths, as well as for calendar binding.

Size	Ref	Price
Small – 140mm	2450	£6.95



THUMBCUT HAND PUNCH

A sturdy hand punch to make a semi-circle thumbcut in the top of a calendar which can then be bound and hung using a calendar hanger. Punch up to 20 80gsm sheets, with a paper guide up to A3 portrait size.

Model	Ref	Price
Hand punch	4457	£18.28



THUMBCUT PUNCH SYSTEM

A multipurpose cutting system which will punch thumbcuts in up to 100 sheets of 80gsm paper at a time. Round 6mm cornering die included, cutting depth of 10mm. Spare cutting disc included.

Model	Ref	Price
Thumbcut system	4451	£102.74



MAKING CALENDARS WITH CASES

This brilliantly simple method for making desktop calendars is very cost effective for long or short runs. Being lightweight and compact, they are ideal for posting. They are popular for printing companies producing calendars in larger quantities, companies producing calendars in-house or for individuals producing just a few calendars for family and friends.

LOWER PRICES on large quantities **call us now!**



CD CALENDAR CASE

External size	Internal capacity	Ref	Pack 50	Pack 200	Pack 1000	Pack 2000+
126x142x9mm	119x137x5mm	7880	£29.00	£79.00	£224.00	POA

This is the original design and the same size as a standard CD case but moulded for use as a calendar case. **FREE delivery on all calendar case orders over over £150 at these prices shown here.**

We'll **PRICE MATCH** or **BEAT**, speak to us now



MINI CALENDAR CASE

External size	Internal capacity	Ref	Pack 50	Pack 500	Pack 1000	Pack 2000+
97x96x8mm	89x92x5mm	7882	£19.90	£99.00	£167.00	POA

A popular smaller version of the square style.



LANDSCAPE CALENDAR CASE

External size	Internal capacity	Ref	Pack 50	Pack 200	Pack 1000	Pack 2000+
190x111x8mm	183x107x5mm	7884	£29.42	£89.76	£359.00	POA

This case gives a 20% larger print area than the CD size and gives scope for other design styles.



A5 CALENDAR CASE

External size	Internal capacity	Ref	Pack 50	Pack 200	Pack 1000	Pack 2000+
215x152x10mm	208x147x6mm	7886	£47.25	£152.25	£624.00	POA

A large size for an impressive calendar that can still be mailed at a low cost.



Guarantape™

TAPES DESIGNED TO BE TRUSTED

Adhesive tapes are one of the most used and valuable tools in a finisher's workshop. You need to be able to trust your tape. **We can help.**

MAKE TAPES EASY

1 What are you using the tape for?

Match your job with the adhesive strength needed.

2 Choose the tape, the type, the width.

We offer flush or finger lift tape, tapes that can be torn or tapes to cut.

3 How many?

The more you buy, the more you save. Buy in bulk for discounts.



TAPE ADVICE

Our experts are available to help you find the right tape for your job – **call now to speak to our team.**

ADHESIVE STRENGTH LEVELS

1

Non-permanent adhesive for use where a product or document will be removed in future.

2

Standard permanent adhesive for common paper-to-paper uses and uncoated materials.

3

Higher tack permanent adhesives for use in box making and with semi-coated surfaces.

4

Very high tack permanent acrylic adhesives for work with glossy surfaces and digital print.

5

High strength crossover adhesives for very demanding finishing work to basic signmaking.

6

Extremely strong signmaking grade adhesives – use with different materials in many situations.

Our advice can only be a guide due to varying materials, uses and environments. So we also offer a free sample service that our customers love – giving you the opportunity to check the tape will work for the job.



Guarantape. PERM/PEEL

ADHESIVE LEVEL

2 1

A removable tape with level 1 adhesive one side and level 2 adhesive the other side for temporary applications.

Width	Roll length	Carton qty	Ref	Per roll single	Per roll carton
6mm	50m	180	6475	£1.13	£0.66
12mm	50m	90	6477	£2.00	£1.18
18mm	50m	65	6479	£3.38	£1.99



Guarantape. STANDARD

ADHESIVE LEVEL

2

The traditional standard tape for general print finishing work. Ideally suited for everyday uncoated stock that has been litho printed.

Width	Roll length	Carton qty	Ref	Per roll single	Per roll carton
6mm flush	50m	180	6422	£0.77	£0.45
6 on 12mm	50m	90	6406	£1.33	£0.78
9mm flush	50m	120	6424	£1.12	£0.65
9 on 15mm	50m	80	6409	£1.96	£1.15
12mm flush	50m	90	6426	£1.54	£0.90
12 on 18mm	50m	65	6412	£2.29	£1.35
18 on 24mm	50m	50	6418	£3.19	£1.87
24 on 30mm	50m	40	6416	£4.26	£2.50
25mm flush	50m	45	6428	£3.15	£1.86
50mm flush	50m	24	6429	£6.31	£3.71



300m and 500m rolls available across these ranges

Typical usage

- Uncoated paper to paper or card
- Litho printed paper and board
- Files and folders
- Lightweight envelopes
- Other low stress uses with firm uncoated surfaces

Guarantape. AGGRESSOR

ADHESIVE LEVEL

3

An advanced double sided tape with a more aggressive adhesive for work with digital print and many coated materials.

Width	Roll length	Carton qty	Ref	Per roll single	Per roll carton
6mm flush	50m	180	6466	£0.89	£0.52
6 on 12mm	50m	90	6453	£1.52	£0.89
9mm flush	50m	120	6468	£1.38	£0.81
9 on 15mm	50m	80	6456	£2.73	£1.60
12mm flush	50m	90	6470	£1.78	£1.05
12 on 18mm	50m	65	6459	£3.07	£1.81
18 on 24mm	50m	50	6464	£4.11	£2.42
18mm flush	50m	65	6471	£2.77	£1.63
25mm flush	50m	45	6473	£3.69	£2.17



Typical usage

- Folders or boxes using materials that have a firm uncoated surface
- Semi-gloss coated papers
- Fixing showcard struts
- Stock with a slightly loose surface that needs a higher initial tack

DOUBLE SIDED TAPES

Most tapes are available as **flush edge** adhesive (e.g. 6mm adhesive tape on a 6mm backing paper) or as a **fingerlift** option (e.g. 6mm adhesive tape on a wider 12mm backing paper) for ease of removing backing paper.

Guarantape™ ULTRA STICK

ADHESIVE LEVEL **4**

A superb acrylic tape for the most demanding applications. Particularly ideal for laminate to laminate and plastics work. This product offers outstanding durability and stability in varying environments and temperatures.



Width	Roll length	Carton qty	Ref	Per roll single	Per roll carton
6mm flush	50m	144	6342	£1.56	£0.91
6 on 12mm	50m	72	6313	£2.30	£1.35
9mm flush	50m	96	6344	£2.30	£1.35
9 on 15mm	50m	64	6315	£4.07	£2.40
12mm flush	50m	72	6346	£3.07	£1.81
12 on 18mm	50m	52	6316	£4.96	£2.92
18mm flush	50m	52	6347	£4.96	£2.92
25mm flush	50m	36	6348	£6.52	£3.83

Typical usage

- Laminate to laminate work
- Boxes or folders where folds are under stress
- Digital printed work
- Work subject to high or low temperatures
- 24 hour curing time necessary after application for full strength

Guarantape™ ENDURANCE

ADHESIVE LEVEL **5**

This tape is suited for demanding print finishing or display/banner work where the Extreme tapes are an overkill. A great high performance tape at an attractive price.



Width	Roll length	Carton qty	Ref	Per roll single	Per roll carton
6 on 12mm	50m	48	6380	£4.44	£2.61
12mm flush	50m	96	6352	£5.27	£3.10
12 on 18mm	50m	32	6382	£6.64	£3.90
18mm flush	50m	60	6354	£6.33	£3.73
18 on 24mm	50m	24	6383	£9.75	£5.73
24mm flush	50m	48	6356	£8.00	£4.71

Typical usage

- Very demanding print finishing work
- Banner edging
- Point of sale assembly
- A budget alternative to our Extreme range

Guarantape™ BANNER HEMMING TAPE

ADHESIVE LEVEL **5**

A tough single sided adhesive tape for hemming banners without the need for welding or double sided taping. With a strong level 5 adhesive.

Width	Length	Ref	Price
40mm	25m	5867	£18.15



Guarantape. TOFFEE TAPE

ADHESIVE LEVEL **5**

Double sided high strength adhesive tape. The high adhesive and glue consistency is ideal for fixing to irregular or textured surfaces. Designed from scratch to give a very high strength adhesive product that is reliably thicker than many on the market (0.8mm) but is still no more expensive than most thinner and lower grade alternatives.



Typical usage

- Permanent flexibility for moving applications
- For sticking to difficult surfaces including Polythene & Polypropylene
- No curing time, fume and solvent free
- Will absorb irregularities in surfaces
- Order a free sample to test on your project

Width	Roll length	Carton qty	Ref	Per roll single	Per roll carton
12 on 24mm	30m	24	6374	£7.81	£6.64
19 on 30mm	30m	20	6376	£9.81	£8.34
24 on 36mm	30m	16	6378	£11.88	£10.09

Guarantape. MARATHON ACRYLIC TAPE

ADHESIVE LEVEL **6**

An ultra high performance acrylic grey tape from the Guarantape Extreme range. Use for demanding situations like metal-to-metal signmaking and manufacturing situations.

Acrylic adhesives have a strong instant 'grab' that will form an immediate bond but the curing process will also take place for 24 hours after application for the bond to reach full strength.



Typical usage

- Used in the signmaking industry
- Sticking aluminium panels together
- Signage
- Box work for constructing large 3D models
- Exhibition stands

Width	Roll length	Carton qty	Ref	Per roll single	Per roll carton
12mm	33m	25	6392	£22.43	£17.94
19mm	33m	16	6394	£35.57	£28.46
24mm	33m	12	6396	£43.29	£34.63

We do custom tapes, roll lengths and widths to customer specifications!

From hook and loop tapes to adhesive foam manufacturing tapes, we can make and cut tapes to almost any preferred sizes, just speak to us for details.



EXTERNAL ULTRA STRONG TAPES

Guarantape™ EXTREME

Extreme tapes are very heavy duty signmaking grade tapes for work with almost all materials and in difficult environments. After application they perform well even in temperature extremes.

Guarantape™ EXTREME POLYESTER

ADHESIVE LEVEL

6

The ultimate thin tape with superior adhesion even in extreme conditions. It can be used for work which will be subject to external conditions and extremes of heat or cold. Widely used in many industrial applications. Transparent when red backing film removed.



Width	Roll length	Carton qty	Ref	Per roll single	Per roll carton
12mm flush	50m	90	6496	£6.94	£4.08
25mm flush	50m	44	6498	£12.88	£7.58
50mm flush	50m	24	6487	£25.56	£15.04

Typical usage

- Point of sale assembly
- Laminates
- Name plates & signage
- Banner edging / mounting
- Manufacturing assembly

Guarantape™ EXTREME TEARABLE

ADHESIVE LEVEL

6

Our unique product which has the characteristics of the Extreme Polyester tape but can be torn rather than cut – a very significant time saver for volume work.



Width	Roll length	Carton qty	Ref	Per roll single	Per roll carton
12mm flush	50m	96	6363	£7.97	£4.69
18mm flush	50m	60	6365	£11.99	£7.05
25mm flush	50m	48	6367	£15.96	£9.39

Typical usage

- Point of sale assembly
- Laminates
- Name plates & signage
- Banner edging / mounting
- Manufacturing assembly

Guarantape™ EXTREME GLUE TAPE

ADHESIVE LEVEL

6

This 1mm thick heavy duty adhesive tape is used for many heavy duty situations, especially where rough, irregular or heavier materials need to be joined. Transparent with exceptional resistance to temperature and UV rays.



Width	Roll length	Carton qty	Ref	Per roll single	Per roll carton
12mm	33m	25	6497	£20.49	£18.12
25mm	33m	12	6499	£40.49	£35.03

Typical usage

- Applications requiring a thicker adhesive tape due to irregular surfaces
- Name plates and signage
- External mounting
- Manufacturing assembly

Guarantape[®] EXTERIOR FOAM TAPE

ADHESIVE LEVEL

5

Super strong black foam tape ideal for exposed or long term external use. For signs or banners exposed to outside conditions or an ideal number plate tape for vehicles.

Width	Roll length	Ref	Per roll single	10+
24mm	50m	6386	£19.51	£17.10
50mm	50m	6388	£37.51	£32.93

Excellent user feedback

Great water resistance and a more permanent adhesive. 1mm thickness.

Guarantape[®] DOUBLE SIDED ADHESIVE DISCS

ADHESIVE LEVEL

5

Double sided adhesive discs with a handy tab for application. Supplied on a roll of 1000 discs. Quick and easy to use, ideal for applying to posters or display work.

Diameter	Ref	Per roll single	10+
15mm	6060	£8.01	£6.81
25mm	6062	£17.01	£14.46
50mm	6065	£30.56	£26.74



NEW!

Guarantape[®] INTERIOR FOAM TAPE

ADHESIVE LEVEL

4

Double sided adhesive foam tape for use on rough and uneven surfaces. Cost effective solution for mounting name plates and signage when the heavier duty glue tape is not necessary. Roll length 50m.

Width	Thickness	Ref	Per roll single	10+
12mm	1mm	6420	£6.80	£5.87
25mm	1mm	6421	£11.71	£10.10
50mm	1mm	6423	£32.29	£25.41

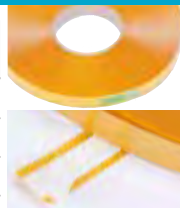

Guarantape[®] FOAM PADS

ADHESIVE LEVEL

4

Pre-cut squares of foam double sided adhesive, supplied on a roll of 2000 pads with a fingerlift backing paper. Ideal for sticking posters or display material to rough or uneven surfaces.

Width	Thickness	Ref	Per roll single	10+
12x12mm	1mm	6430	£9.75	£8.29
25x12mm	1mm	6432	£19.67	£16.72
25x25mm	1mm	6434	£26.10	£22.19
25x25mm	2mm	6439	£27.65	£23.50



Guarantape[®] DOUBLE SIDED ADHESIVE SQUARES

ADHESIVE LEVEL

2

1

Pre-cut 12mm squares of double sided adhesive tissue tape. 1000 squares on a roll with easy fingerlift backing.

Width	Type	Ref	Per roll single	10+
12mm	Perm/Perm	6483	£9.37	£6.56
12mm	Perm/Peel	6485	£9.37	£6.56

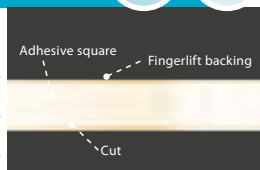

ATG – THE EASIER WAY TO TAPE!

Guarantape™ ATG SYSTEM

ATG is a unique double-sided applicator system that applies tape and removes the backing paper in one simple action. No more cutting the tape, applying by hand and then having to peel the backing paper off.



Tapes can be bought in singles or a lower carton price.

Guarantape™ ATG APPLICATOR

A sturdy applicator gun for ATG tapes and glue dots, to be used with the double sided tapes and glue dots below. The 6mm adapter is needed when using with the 6mm double sided tape.



Product	Ref	Price
Applicator Gun	6031	£25.94
Adapter piece for 6mm tape	6032	£9.77

NEW
ATG SYSTEM
STARTER KITS
on page 42



ATG tapes are applied with a special gun applicator – saving hours over normal tape!

See the benefits of the ATG System on our YouTube channel at presco.eu/video

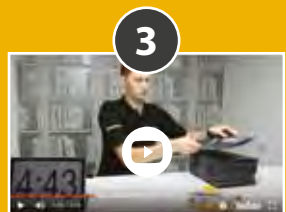
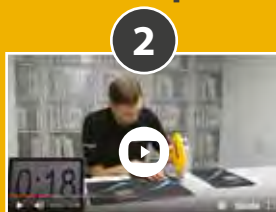



Guarantape. ATG DOUBLE SIDED TAPES

Double sided tapes for the ATG applicator system. High quality, individually wrapped rolls of tape. Use to fix showcard struts, pockets, mounting and file making. Save by buying in carton quantities.

Type	Width	Length	Carton qty	Ref	Singles	Per carton	Adhesive level
Standard	6mm	55m	144	6033	£3.00	£1.73	2
Standard	12mm	33m	72	6035	£2.96	£1.70	2
Standard	12mm	55m	72	6038	£4.16	£2.39	2
Ultra Stick	12mm	33m	72	6039	£5.66	£3.25	4
Perm/Peel	12mm	30m	72	6037	£3.14	£1.81	2/1
Standard	19mm	33m	48	6036	£4.26	£2.45	2

Guarantape. ATG GLUE DOTS

Glue dots on rolls of 1500 for use with the ATG gun. Dots are 9mm diameter by 1mm thickness.

NEW – Aggressor extra strength glue dots now available.



Type	Dots / roll	Diameter	Carton qty	Ref	Singles	Per carton	Adhesive level
Removable	1500	9mm	24	6491	£9.31	£5.58	1
Standard	1500	9mm	24	6492	£9.31	£5.58	2
Aggressor	1500	9mm	24	6490	£10.65	£6.39	3

|| The ATG system saved over 14 hours on one job alone.

Specialist print finisher, London

We'll **PRICE MATCH** or **BEAT**, speak to us now

ATG TAPING KITS

See how well the ATG system could work for you by trying out one of our starter packs. Contents of each kit and the savings are listed below.

ATG COMPLETE STARTER KIT

SAVE OVER
£35



Double Sided Tape Applicator **6031**
 6mm Tape Adapter **6032**
 6mm Permanent 50m Roll **6033**
 12mm Permanent 50m Roll **6038**
 12mm Perm/Peel 30m Roll **6037**
 12mm Ultra Stick 33m Roll **6039**
 19mm Permanent 30m Roll **6036**
 Removable Glue Dots **6491**
 Permanent Glue Dots **6492**

ATG STARTER KIT

SAVE OVER
£15



Double Sided Tape Applicator **6031**
 12mm Permanent 33m Roll **6035**
 12mm Ultra Stick 33m Roll **6039**
 19mm Permanent 30m Roll **6036**

ATG GLUE DOTS APPLICATOR KIT

SAVE OVER
£15



Double Sided Tape Applicator **6031**
 Removable Glue Dots **6491**
 Permanent Glue Dots **6492**

Guarantape™
 Save hours over using normal tape!

NEW
 ATG SYSTEM
 STARTER
 KITS

Kit	Ref	Price
ATG Complete Starter Kit	ATG1	£39.99

Kit	Ref	Price
ATG Starter Kit	ATG2	£27.99

Kit	Ref	Price
ATG Glue Dot Applicator Kit	ATG3	£29.99

AUTOMATIC TAPE CUTTER

THE ORIGINAL AND THE BEST

Presco has sole UK distributorship for the original Yaesu tape cutting machines. Designed and made in Japan, these are superior to any copies and work reliably and consistently year after year.

This dispenser is incredibly efficient for anyone carrying out large amounts of taping. It can be set to cut lengths of tape from 20mm to 999mm and handles tape widths from 6mm to 50mm on 76mm, 35mm and 25mm cores.

Can be set to automatically cut the next length as soon as the operator removes the cut tape.

See this in
action!



go to
[presco.eu/
autocut](http://presco.eu/autocut)



Core size	Width	Cuts into lengths	Ref	Price
25, 35 or 76mm	6-50mm	20 up to 999mm	0454	£549.83

Guarantape

SPINE TAPE

Spine bookbinding linson tape, embossed with a fabric effect. A premium heavy stock paper based tape with a strong permanent adhesive that will cure completely over a 24 hour period after application. Used for finishing stapled pads and for bookbinding.

Width	Length	Black	White	Dark Blue	Red	Dark Green	Price	10+
25mm	50m	5010	5011	5012	5013	5014	£5.83	£4.37
38mm	50m	5020	5021	5022	5023	5024	£7.79	£5.85
50mm	50m	5030	5031	5032	5033	5034	£11.55	£8.67
75mm	50m	5040	5041	5042	5043	5044	£16.78	£12.58



MULTI TAPES

Versatile 9mm width double sided tape applicators, with tape pre-cut to separate at intervals of 1.5mm. Fast, precise and a bestseller for craft work or mounting purposes. Single use 10m applicators.

Adhesive	Length	Ref	Price	20+	100+
Permanent	10m	6050	£3.73	£2.98	£2.24



GLUE DOTS

Our most popular adhesive product ever! Easy to use dispenser boxes make these clear dots fast and simple to apply. Ideal for mailing attachments, attaching plastic cards to letters, retail packaging and many display uses. Each box has 5000 dots. These are 9mm diameter and 1.5mm thick.

Type	Dots per box	Ref	Price	10+
Removable	5,000	6493	£18.24	£13.68
Permanent	5,000	6495	£18.89	£14.16



Presco hook & loop

BACK TO BACK HOOK & LOOP TAPE

Back to back hook and loop is a single tape with hook fixing on one side and loop on the other making it perfect for cutting for use as loops, using on displays, hanging and fixing. It is the ideal product where you require looping for wires, cables etc.

This hook and loop tape is supplied in 2 widths and on rolls making it easy to cut to the length you need. You can attach and detach display items over and over again.

Width	Length	White	Black	Price	10+
25mm	25m	1221	1220	£32.63	£24.47
50mm	25m	1241	1240	£63.88	£47.91



SEW ON HOOK & LOOP TAPE

Classic strong hook and loop tape for industrial and fabric applications. Can be easily sewn, stapled or glued to different surfaces. We supply a very wide range of hook and loop tapes and fixings, most is stocked for next day delivery, some tapes may be a 2-3 day delivery. Get in touch if you're looking for a different size or for more details.

Width	Type	Length	White	Black	Price	10+
25mm	Hook	25m	1381	1382	£7.50	£6.00
25mm	Loop	25m	1391	1392	£7.50	£6.00
50mm	Hook	25m	1387	1386	£27.13	£21.70
50mm	Loop	25m	1395	1396	£13.95	£11.16
100mm	Hook	25m	1387	1388	£27.13	£21.70
100mm	Loop	25m	1397	1398	£27.13	£21.70



Presco SPECIALS

We can supply hook and loop fixings in many sizes, adhesives and types, call us now on **01793 716300**

ADHESIVE HOOK & LOOP TAPE

A high performance tape with strong adhesive backing. A range of widths is available, from narrow 12mm up to a very wide 50mm tape which forms an incredibly strong fixing. Samples upon request.

Width	Type	Length	White	Black	Price	10+
12mm	Hook	50m	7379	-	£15.13	£11.35
12mm	Loop	50m	7389	-	£15.13	£11.35
16mm	Hook	25m	7381	7382	£7.03	£5.27
16mm	Loop	25m	7391	7392	£7.03	£5.27
25mm	Hook	25m	7385	7386	£10.17	£7.63
25mm	Loop	25m	7395	7396	£10.17	£7.63
50mm	Hook	25m	7387	-	£18.00	£13.50
50mm	Loop	25m	7397	-	£18.00	£13.50



ADHESIVE HOOK & LOOP DISCS

Round discs (also known as Coins) for many applications for fixing posters and display material. Strong adhesive backing, simply peel off backing paper and they are ready to use. Samples upon request.

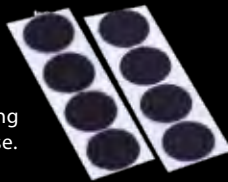

Diam.	Type	Qty/Roll	White	Black	Price	10+
12mm	Hook	1500	7401	7402	£12.39	£9.30
12mm	Loop	1500	7411	7412	£12.39	£9.30
22mm	Hook	1000	7405	7406	£14.76	£11.07
22mm	Loop	1000	7415	7416	£14.76	£11.07



PACKAGING TAPES & DISPENSERS

SAVE
on CARTON
PACKS!

STANDARD PACKING TAPE GUN & TAPES



Regular packaging tapes 50mm width on 66m rolls with a 76mm core for use with all standard tape gun dispensers. Supplied in clear, buff (brown) or fragile red/white variations and with special low noise formulation. Sturdy, good quality standard packaging gun dispenser available for these tapes as shown.

Type	Length	Rolls/ carton	Ref	Price	1+ Cartons
Dispenser gun	-	-	6510	£9.44	-
Buff low noise	66m	36	6500	£1.95	£0.98
Clear low noise	66m	36	6502	£1.95	£0.98
Fragile	66m	36	6509	£2.86	£1.71

E-TAPE PACKING GUN & TAPES



E-Tape is a faster and more economical taping system with much longer roll lengths of 150m due to a special 50mm core size, saving time, roll changes and cost. These rolls can only be used with the E-Tape dispenser gun, as below. Available in clear or buff (brown).

Type	Length	Rolls/ carton	Ref	Price	1+ Cartons
Dispenser gun	-	-	6511	£11.15	-
E tape Clear	150m	36	6503	£2.25	£2.01
E tape Buff	150m	36	6501	£2.25	£2.01

Note this packing gun is only for use with 50mm core E-Tape.

SELLOTAPE

Popular clear adhesive tape for any purpose, available on 66m rolls as branded Sellotape or an economy version.

Type	Width	Length	Ref	Price
Standard	24mm	66m	6513	£5.95
Economy	24mm	66m	6514	£3.14



SCOTCH MAGIC TAPE

High quality craft and mounting tape, almost invisible once applied and will not deteriorate or yellow with age.

Type	Width	Length	Ref	Price
Permanent	12mm	33m	6596	£3.89
Permanent	19mm	33m	6597	£4.65
Removable	19mm	33m	6598	£5.92



CROSS-WEAVE PACKAGING TAPE

A super strong adhesive tape reinforced with glass fibre woven filaments. Cannot be torn by hand and suited for very demanding applications.

Width	Length	Ref	Price
25mm	50m	5860	£4.15
50mm	50m	5863	£7.44
75mm	50m	5865	£11.59



EXHIBITION CARPET TAPE

Approved by the National Exhibition Centre and other major centres for use on their floors. One side is standard adhesive and the other side is removable so it does not leave residue on the floor.

Width	Length	Ref	Price
48mm	50m	5857	£9.91



MASKING TAPE

White crepe masking tape for studio work and many other specialist print and craft uses. Remove within 24 hours after use for a perfect finish.

Width	Length	Ref	Price
25mm	50m	6595	£1.95
50mm	50m	6594	£3.52



CRYSTAL™ SECURE CLEAR PRODUCTS FOR DISPLAY PACKAGING

CRYSTAL™ DISC DISPENSER

Crystal discs are difficult to use with many automatic applicators or dispensers as they are completely transparent. The new D360 dispenser has been designed especially to work with our crystal discs and is a very high quality electric dispenser for all labels.



Product	Ref	Price
Crystal Disc Dispenser	6551	£663.11

CRYSTAL™ DISCS

Type	Diam.	Roll	Ref	Price	20+
Permanent	19mm	2000	6515	£8.22	£4.52
Removable	19mm	2000	6517	£8.22	£4.52
Permanent	25mm	1000	6521	£10.71	£5.89
Removable	25mm	1000	6524	£10.71	£5.89
Perforated	25mm	1000	6527	£11.36	£6.25
NEW! Biodegradable	25mm	1000	6563	£13.80	£8.97
Permanent	38mm	1000	6530	£16.01	£8.80
Removable	38mm	1000	6532	£16.01	£8.80
Perforated	45mm	1000	6534	£23.79	£13.09
Permanent	50mm	1000	6541	£23.79	£13.09
Removable	50mm	1000	6543	£23.79	£13.09

Clear adhesive discs for sealing wallets, folders, brochures and many other uses.

High quality glossy polypropylene and available in many sizes, with perforated options for easy opening when breaking the seal. Supplied on rolls as sticky round labels, can be applied by hand or used with the Crystal Disc applicator gun. Note that perforated discs have permanent adhesive.

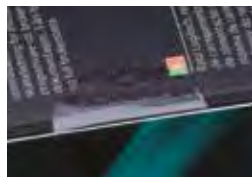

CALL US FOR SPECIAL QUANTITY DISCOUNT PRICES!

We do custom tapes, roll lengths and widths to customer specifications!

From hook and loop tapes to adhesive foam manufacturing tapes, we can make and cut tapes to almost any preferred sizes, just speak to us for details.



HOT MELT GLUE STICKS

Product	Pack size	Ref	Price
Hot melt glue sticks	1	6015	£59.42

Glue sticks are supplied by weight in 5kg cartons, approximately 150 sticks 12mm x 300mm.



PADDING SUNDRIES

Product	Pack size	Ref	Price
Padding brush	1	6135	£8.95
Budget padding knife	1	6138	£11.68
Premium padding knife	1	6139	£32.10
75mm gauze	50m	6142	£11.68
150mm gauze	50m	6147	£23.25

Padding tools and accessories to ensure a good result on pads, notebooks and any other glued products.



PADDING PRESS

Size	Ref	Price
up to SRA3	0401	£348.74

A solid and durable metal padding press for all pads up to SRA3 paper size. Capacity up to 10,000 A4 sheets depending on paper weight. Use with our standard Presco padding adhesive for consistent results every time.



ADHESIVES

Adhesives for padding, Fanapart binding (NCR sets), perfect binding and mounting work.

See our website for more information:

presco.eu/collections/sticking/adhesives



Product	Used for	Pack size	Ref	Price
Presco padding adhesive	Padding	5 litres	6100	£29.54
Fanapart padding adhesive	Carbonless invoice sets etc.	2 litres	6107	£58.90
Perfect binding adhesive	Hot melt spine glue for perfect binding	5kg	6113	£69.80
Perfect binding adhesive	Hot melt spine glue for perfect binding	20kg	6115	£151.75
Spraymount 400ml (repositionable)	Spray adhesive for mounting and artwork	1 can	6000	£19.98
Displaymount 400ml (permanent)	Heavy duty mounting spray adhesive	1 can	6001	£19.79

CUSTOMISED SPECIALS FOR EVERY JOB

+much,
much
more!

have a look what we've done in the last year

There are 1000s of custom solutions available, **call our specials department on 01793 716300 for advice, a quote or free samples**

Custom widths,
colour, paired
and cut to length

hook & loop

Mag tape cut
to length

MAGSURE

Different size
mag discs

Printed lanyards

Bespoke
literature
dispensers

Custom width
lamination films

Pre-cut string
and ribbon
lengths

Custom postal tubes

Custom width double sided tapes



Bespoke cut wire lengths



Guillotine blades



Custom ball chain lengths and colours



Banner accessories, printed packaging tapes and custom display products

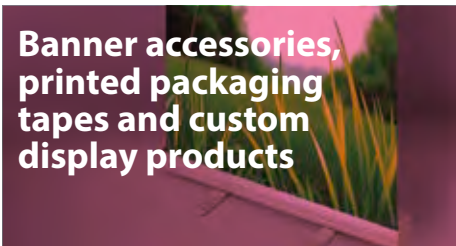

Custom sized plastic pockets adhesive and non-adhesive

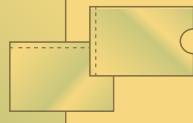

Pre-taped *Presco* showcard struts

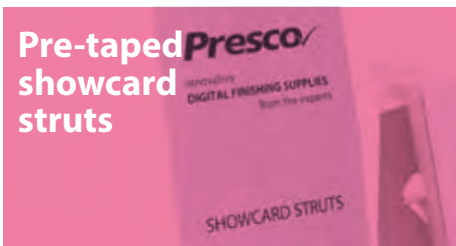

Custom size poly bags



Corner protectors



Long tape rolls



There are 1000s of custom solutions available, **call our specials department on 01793 716300 for advice, a quote or free samples**

Presco **MAGSURE**

Magnetic discs are very popular for all types of assembly work requiring magnetic fixing or closures. They are super-strong magnets for their size and come with or without adhesive backing.

We'll **PRICE MATCH** or **BEAT**, speak to us now

ADHESIVE MAGNETIC DISCS

Adhesive magnetic closer discs, supplied in pairs to create clever fixings in boxes, folders, diaries and displays. High quality 3M adhesive backing with an easy peel tab to apply. Pack of 50, 100 or 1000 pairs.

Diameter	Thickness	Ref	50 Pairs	100 Pairs	1000 Pairs
9.5mm	0.75mm	7365	-	£21.85	£194.28
9.5mm	1.5mm	7366	£20.09	-	£351.50
15mm	1mm	7368	£24.23	-	£414.96



MAGNETIC DISCS

Powerful magnetic discs which can be used for hidden closure of files, cases and boxes. These are supplied in singles, not pairs, and do not have any adhesive backing. Pack of 100 or 1000 single discs.

Diameter	Thickness	Ref	100 Singles	1000 Singles
6mm	2mm	7363	£12.47	£84.00
9.5mm	2mm	7361	£20.85	£177.36
14mm	2mm	7362	£28.53	£254.36



ADHESIVE MAGNETIC TAPE

Heavy duty magnetic tape with a high quality adhesive backing, cut to required length quickly and easily. To use this as pairs you will need to order type A and type B (opposite polarities of the magnetic tape).

Type	Thickness	Width	Length	Ref	Price
A	1.6mm	12.5mm	30m	7367	£18.55
A	1.6mm	25mm	30m	7369	£37.10
B	1.6mm	12.5mm	30m	7374	£18.55
B	1.6mm	25mm	30m	7376	£37.10



Magnets have an invisible force that will always be of interest and a talking point when used. Now we see them used increasingly in presentation and display as they add a unique closure that stands out as a luxury product.

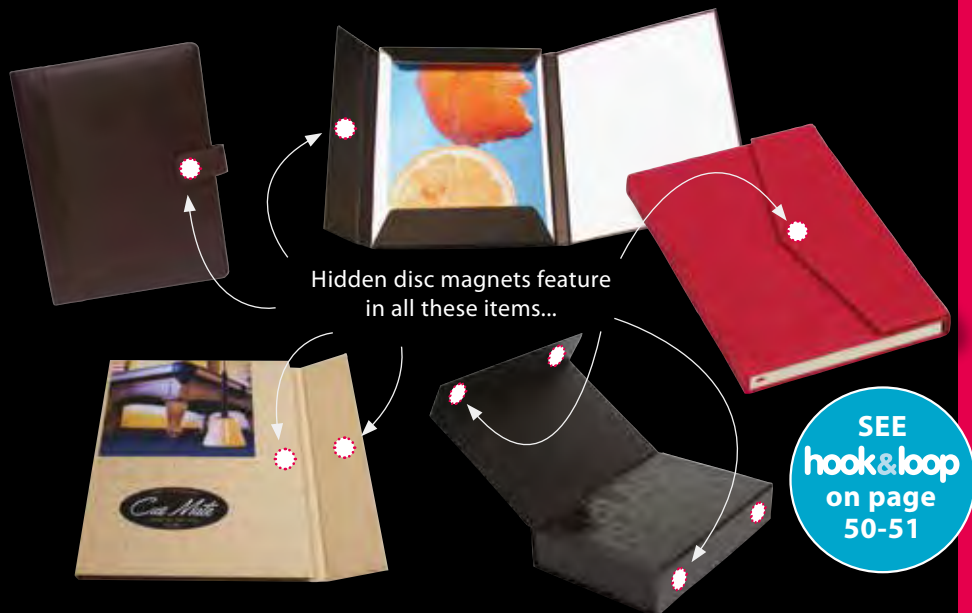

MAGNETIC CLOSER PATCHES

Rectangular rubber magnetic strips, adhesive backed and supplied in pairs.

Diameter	Thickness	Ref	100 Pairs	1000 Pairs
25x15mm	0.5mm	7372	£14.94	£82.19

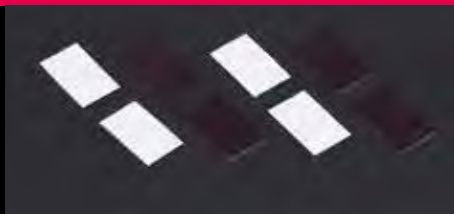

MAGNETIC ADHESIVE CUT STRIPS

Supplied in sheets of 72, these 15mm x 25mm magnetic strips are also self-adhesive, so can be used for fridge magnets or attach to display items. Thickness 0.5mm. Will support up to 6g per strip.

Size	Thickness	Ref	Pack 1000	Pack 5000
15x25mm	0.5mm	7364	£29.73	£101.55

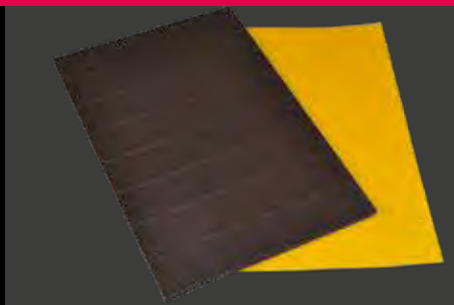

PLASTIC POCKETS

- ✓ 100% crystal clear
- ✓ Made from premium quality polypropylene
- ✓ Environmentally neutral, fully recyclable
- ✓ Low static – they won't stick together
- ✓ Long lasting – they won't curl or discolour

ADHESIVE CORNER POCKETS

Size	Ref	Pack 100	Pack 1000
32x32mm	6903	-	£22.28
75x75mm	6908	£6.84	£44.45
100x100mm	6910	£7.79	£50.64
140x140mm – A5	6914	£13.51	£87.82
170x170mm – A4	6917	£22.08	£154.55

Clear plastic adhesive corner pockets for securing documents, photos and inserts into a folder, brochure or album.

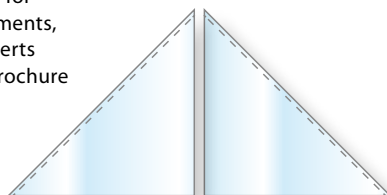

ADHESIVE ANGLED POCKETS

Angled adhesive pockets to fit A4 portrait sheets. Closed at the bottom and both sides.

Type	Ref	Pack 100	Pack 1000
Right hand	6952	£28.43	£195.13
Left hand	6953	£28.43	£195.13

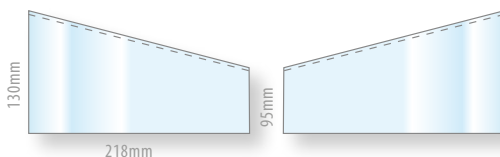

ADHESIVE CARD HOLDER POCKETS

Type	Size	Ref	Pack 50	Pack 100	Pack 500	Pack 1000
Business card – open short edge	60x95mm	6930	-	£10.60	-	£57.94
Business card – open long edge	95x60mm	6929	-	£10.60	-	£57.94
Business card – with flap	105x60mm	6928	-	£16.11	-	£98.47
A6 open short edge	115x158mm	6956	£9.57	-	-	£123.63
A6 open long edge	158x115mm	6951	£11.00	-	-	£110.10
A5 open short edge	158x220mm	6955	£16.73	-	-	£217.53
A5 open long edge	220x158mm	6958	£17.60	-	-	£219.68
A4 open short edge	220x302mm	6954	£24.49	-	£165.80	-
A4 open long edge	302x220mm	6959	£24.20	-	£163.24	-
A3 open short edge	303x440mm	6957	£70.06	-	-	-

Adhesive pockets to take various size cards.

Card Holder 6930 has thumbcut on short edge for ease of insertion.

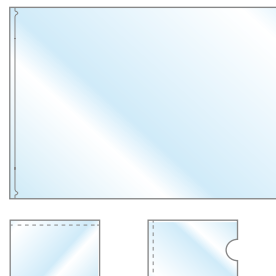

ADHESIVE MEDIA & PERMIT POCKETS

We'll **PRICE MATCH** or **BEAT**, speak to us now

Type	Size	Ref	Pack 100	Pack 1000
CD Pocket	127x127mm	6931	£21.32	£138.55
CD Pocket with flap	127x127mm	6933	£24.21	£157.36
Parking Permit and Diskette Pocket	105x100mm	6935	£14.61	£94.97
Parking Permit and Diskette Pocket with flap	105x105mm	6937	£16.52	£107.38
Memory card pocket with flap	52x58mm	6938	£8.98	£58.38
USB stick pocket with flap	52x90mm	6936	£12.15	£78.99

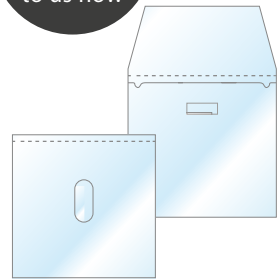

A range of clear adhesive pockets for CDs, memory cards, diskettes and USB sticks. Add to a presentation folder for a smart, secure fixing.

NON ADHESIVE CARD HOLDER POCKETS

Type	Size	Ref	Pack 100	Pack 1000
Business card	60x90mm	6985	£16.89	£121.32
A7	80x105mm	6967	£13.50	£107.09
A6	115x155mm	6966	£14.48	£119.84
A5	158x213mm	6965	£16.32	£115.46
A4	238x308mm	6964	£21.20	£173.69



Card holder pockets open short edge, can be used as protective sleeves for membership cards, licences, leaflets and other documents. All pockets are oversized to take the sizes shown. All open on the short edge and have a thumbcut except the 60 x 90mm pocket. The card holders are made from recyclable and environmentally friendly polypropylene, with the exception of business card size pockets that are crystal clear PVC.

NON ADHESIVE CD POCKETS

Type	Size	Ref	Pack 100	Pack 1000
CD Pocket with flap	125x127mm	6934	£10.06	£64.77
CD Pocket plus margin	127x140mm	6939	£35.74	£250.15

Clear PVC plastic pockets to take a single CD, with flap to secure. Margin pocket offers easy binding into a presentation folder. The card holders are made from recyclable and environmentally friendly polypropylene, with the exception of business card size pockets that are crystal clear PVC.

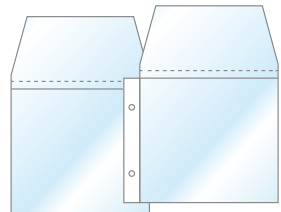

More sizes and pocket styles can be found at presco.eu

CORDS, TASSELS & TAGGING

ELASTICATED LOOPS

Size	Pack 100	Pack 1000	Colour	A4 spine	A5 spine	A6 spine
A4 spine	£23.67	£161.30	Black	7900	7910	7920
A5 spine	£23.28	£143.14	Royal Blue	7902	7912	7922
A6 spine	£21.55	£120.31	Green	7904	7914	-
			Silver	7908	7918	7928
			Gold	7905	7915	7925
			White	7901	7911	7921
			Red	7903	7913	7923
			Gold with ball	7965	7975	-
			Silver with ball	7968	7978	-

Elasticated loops firmly hold folded pages in the spine of a cover and it's easy to add or remove pages. Can be used for menus or an order of service. Available in three standard sizes and in a number of colours.



We supply custom loops in over 50 different colours and 10 different grades of elastic – **Speak to us for a free quote and samples.**

**PRICE
& QUALITY
GUARANTEE**

Direct from the factory to you means we can give the **very best prices and consistent checked quality** on bulk orders. Try us!

ELASTICATED CORD REELS

Product	Colour	Ref	50m	300m	500m	
Flat Braid	Black	7935	-	£42.66	-	6mm flat elasticated braid for use as a cover fixing on diaries, presentation folders and for other display purposes.
Flat braid	White	7934	-	£42.66	-	
Round cord	Black	7930	£10.60	-	£53.69	
Round cord	White	7931	£10.60	-	£53.69	
Round cord	Silver	7939	£10.60	-	£53.69	1.5mm diameter round elasticated cord for tagging, fixing and point of sale and for display purposes.
Round cord	Gold	7938	£10.60	-	£53.69	



TASSELS

Our A4 (double ended – to fit max 330mm spine) and A5 (double ended – to fit max 225mm spine) spine tassels have an adjustable clear sliding tube, meaning that they can fit various sizes of printed materials. Tassels are available in an extensive range of colours.

Bookmark tassels are single floss ended tassels with a 100mm loop, ideal for attaching to labels, invitations, bottles and gifts, and are available in many colours.

Size	Pack 100	Pack 1000	Colour	A4	A5	Book- mark
A4	£39.46	£292.00	Black	7450	7420	7480
A5	£35.87	£279.82	White	7451	7421	7481
Bookmark	£20.05	£159.29	Blue	7452	7422	7482
			Red	7453	7423	7483
			Dark Green	7454	7424	7484
			Silver Grey	7458	7428	7488
			Maroon	7459	7429	7489
			Navy	7462	7432	7492
			Old Gold	7465	7435	7495



RIBBON

Width	Length	Price	Colour	7mm	15mm
7mm	91m	£13.81	Black	7940	7950
15mm	91m	£20.83	White	7941	7951
			Navy Blue	7942	7952
			Red	7943	7953
			Green	7944	7954
			Gold	7945	7955

High quality satin ribbon for finishing documents, boxes, diaries and much more.



RAYON CORD

Colour	Ref	50m roll	500m roll	Strong twisted cord for tagging and display purposes on large 50m or 500m rolls. 1.5mm diameter cord.
Black	7990	£9.19	£42.89	
White	7991	£9.19	£42.89	
Navy	7992	-	£42.89	
Red	7993	-	£42.89	



BINDING SCREWS



We'll **PRICE MATCH** or **BEAT**, speak to us now

Solid metal binding screws turned from brass, with a brushed matt finish or a more contemporary silver nickel coated finish.

Find full technical specifications and latest pricing for binding screws online at presco.eu. Non-standard binding screws also available from stock and are shown on the next page.

All metal binding screws have a shaft diameter of 5mm, requiring a 6mm hole. Thread size is M4. Also known as Post Screws or Chicago Screws.

NICKEL FINISH

Capacity	Ref	Pack 100	Pack 1000
2mm	7181	£18.81	£103.44
3.5mm	7183	£19.09	£104.97
6mm	7185	£19.20	£105.62
7.5mm	7186	£21.15	£116.34
10mm	7187	£21.10	£116.04
13mm	7189	£23.11	£127.12
16mm	7191	£24.67	£135.71
20mm	7193	£28.67	£157.67
25mm	7195	£31.37	£172.53

BRASS FINISH

Capacity	Ref	Pack 100	Pack 1000
2mm	7215	£18.81	£103.44
3.5mm	7217	£19.09	£104.97
6mm	7219	£19.20	£105.62
7.5mm	7221	£21.15	£116.34
10mm	7223	£21.10	£116.04
13mm	7225	£23.11	£127.12
16mm	7228	£24.67	£135.71
20mm	7231	£28.67	£157.67
25mm	7234	£31.37	£172.53

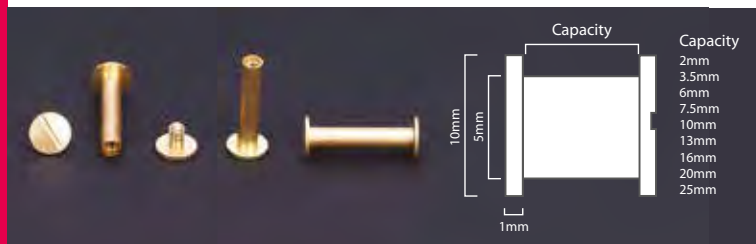

BLACK METAL BINDING SCREWS

New in stock, these metal binding screws have a contemporary black satin finish with the same dimensions as a regular metal binding screw.

Capacity	Ref	Pack 100	Pack 1000
5mm	7695	£20.40	£122.40
10mm	7697	£22.20	£133.20



For full technical information and pricing – visit presco.eu

SERRATED EDGE BINDING SCREWS

A design variation on the traditional binding screw, serrated edge for both decorative and increased grip purposes. Brushed brass finish or polished nickel coating. Serrated binding screws are also known as fluted screws.

Capacity	Type	Ref	Pack 100	Pack 1000
3.5mm	Brass	7613	£30.18	£160.49
3.5mm	Nickel	7628	£34.76	£185.80
6mm	Brass	7615	£30.19	£160.49
6mm	Nickel	7630	£34.76	£185.80
10mm	Brass	7617	£33.41	£231.33
10mm	Nickel	7632	£39.32	£231.33

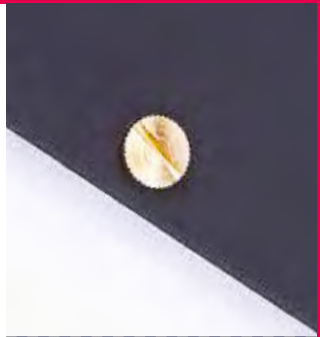

BINDING SCREW EXTENSION POSTS

Nickel plated brass extension posts for standard, serrated and double base binding screws. Hidden once assembled and in use. Not for use with plastic binding screws. Increase capacity up to 50mm.

Capacity	Ref	Pack 100	Pack 1000
6mm	7240	£12.82	£70.51
10mm	7242	£18.39	£101.12
13mm	7244	£19.20	£105.63
20mm	7246	£30.05	£165.25
25mm	7248	£31.88	£175.32



DOUBLE BASE BINDING SCREWS

3 part brass binding screw for swatches to be fixed to a surface or made with an extra base board. A 6 or 6.5mm hole will need to be drilled to take this screw.

Capacity	Ref	Pack 100	Pack 1000
13mm	7684	£51.59	£338.00
16mm	7686	£56.78	£316.77
20mm	7688	£61.32	£380.60
25mm	7690	£67.05	£368.79

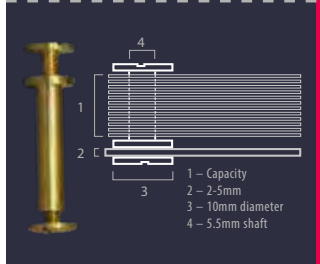

PLASTIC BINDING SCREWS

An economical alternative to standard metal binding screws, plastic screws have a much bigger range of capacities and are stocked in black or white plastic. Can be screwed together as normal or even hammered together for rapid assembly where the screws will not need to be reused. A 6mm hole needs to be drilled to take these screws.

Capacity	White	Black	Pack 100	Pack 1000
5mm	7251	7250	£29.09	£73.43
7mm	7253	7252	£29.09	£73.43
10mm	7255	7254	£29.09	£73.43
13mm	7257	7256	£29.09	£73.43
16mm	7259	7258	£31.99	£81.85
20mm	7261	7260	£31.99	£81.85
25mm	7263	7262	£31.99	£81.85
30mm	7265	7264	£33.07	£95.10
35mm	7267	7266	£33.07	£100.33
40mm	7269	7268	£36.17	£116.76
45mm	7271	7270	£36.17	£108.17
50mm	7273	7272	£36.17	£109.88



PRESCO SWATCH FASTENERS



These clever fasteners are our own innovative design that allows you to add a loop through any swatch. Simple two-part push together fittings, with a range of capacities that click down to an exact fit and can't come undone. Ideal for security uses as well as display. Through the centre is a 3mm hole that can be used for cord or chain.

Capacity	Clear	Silver	White	Pack 100	Pack 1000
0-3mm	7507	7508	7501	£13.22	£68.55
3-6mm	7527	7528	-	£14.71	£80.74
6-9mm	7547	7548	-	£16.87	£91.25

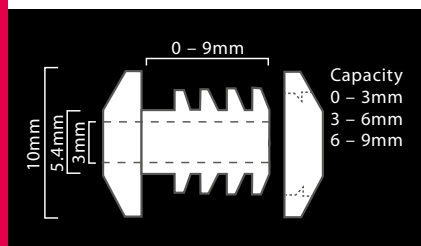

Capacity
0 - 3mm
3 - 6mm
6 - 9mm



NICKEL BALL CHAIN



CUT LENGTH CHAIN LOOPS

Shiny nickel finish metal ball chain for tagging, display and swatches. Cut lengths supplied with connectors, from 100mm lengths right up to a necklace 760mm length chain. No. 3 chain size.

Length	Ref	Pack 100	Pack 1000
100mm	7125	£15.97	£97.85
150mm	7126	£18.54	£114.23
230mm	7129	£33.73	£185.40
760mm	7127	£43.88	£258.93

REELS OF BALL CHAIN

Large 500m long reel of nickel ball chain for tagging to exact sizes. Cut quickly and easily with wire cutters (page 38).



Product	Ref	Price
Reel	7124	£138.79

BARREL CONNECTORS

Barrel connector pieces for use with nickel ball chain to create your own sized loops.



Product	Ref	Pack 1000
Connector	7123	£26.57

STEEL BINDING RINGS

Hinged steel binding rings with a sturdy click together fastening. Maximum capacity is 10-20% less than diameter. 14, 19 and 25mm binding rings supplied open as standard.

Diameter	Supplied	Ref	Pack 100	Pack 1000
14mm	Open	7203	£14.61	£80.33
19mm	Open	7205	£15.89	£84.14
25mm	Open	7207	£17.87	£98.27
32mm	Closed	7209	£19.83	£109.04
38mm	Closed	7211	£22.43	£123.36
50mm	Closed	7213	£27.00	£148.49



SNAP STUDS

A quick and effective swatch fastening, simply snap together through any document or swatch for a permanent closure. Available in 3 fixed capacities – for a tighter fastening see our Swatch Fasteners.

Capacity	Black	White	Pack 100	Pack 1000
2.5mm	7560	7561	£8.91	£41.84
5mm	7562	7563	£10.14	£50.20
7.5mm	7564	7565	£12.97	£72.11



LOOP CLIPS

Swatch fastening clips forming an extra plastic loop for hanging the finished document or attaching tags. White flexible plastic. Strap length 72mm.

Capacity	Ref	Pack 100	Pack 1000
4mm	7595	£23.03	£113.54

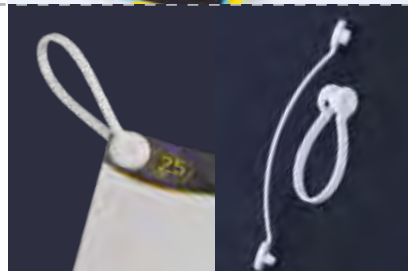

MINIFIX CLIPS

Tiny clip together snap rivets for use as a swatch fastener, binding method, or a popular for cardboard wheel calculators / info discs / colour wheels. The head diameter is 10mm and the capacity is 1.5mm. Hole size is 5mm.

Capacity	Ref	Pack 100	Pack 1000
1.5mm	7651	£12.17	£66.51

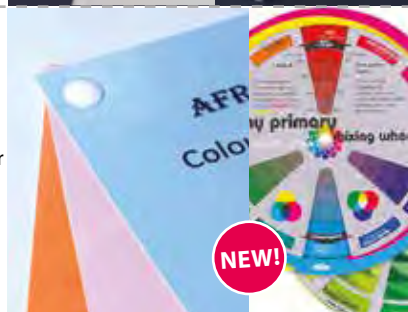

JUTE STRING

Length	Ref	Price	Price 6+
140m	6300	£6.83	£5.47

A tough jute string for a rustic finish to tags, folders and other creative applications. Each ball holds approx 140m of string.



ELASTICATED TREASURY TAGS

Elasticated tags for fastening documents, use in swatches and files and lots more! Silver coloured metal T-ends for extra strength.

Length	Colour	Ref	Pack 100	Pack 1000
100mm	White	7980	£8.98	£51.37
150mm	White	7981	£10.58	£60.15

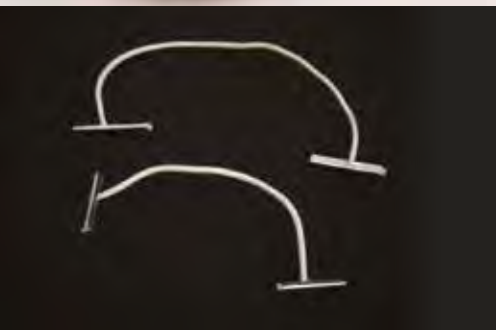

TAGGING STRING AND WIRE

Uniform 254mm lengths of cotton thread string or wire for tagging and display use.

Length	Pack	Ref	Price
10" (254mm) string	2000	6581	£31.63
10" (254mm) wire	1000	6580	£19.93



NYLON SECURITY LOOPS

Length	Ref	Pack 5000
75mm	6210	£42.61
125mm	6214	£44.56
225mm	6217	£48.99

Simple plastic security fixings to affix a label or tag to any item.



CABLE TIES

Length	Width	Ref	Pack 1000
100mm	2.5mm	6220	£9.53
200mm	3.6mm	6224	£19.63
200mm	2.5mm	6227	£13.31

Cable ties are made of a very tough nylon and ensure the security of display materials by locking firmly into place.

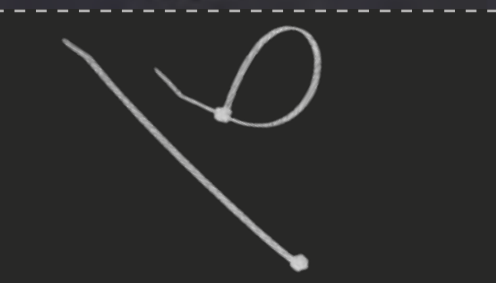



Custom sizes and bulk trade prices available, call us now **01793 716300**

Call for pricing on large quantities

LITERATURE DISPENSERS

1 WALL MOUNTED POSTER HOLDERS

Size	Capacity	Ref	Price
A5 Portrait	3mm	7775	£2.67
A4 Portrait	3mm	7774	£4.49
A3 Portrait	3mm	7773	£9.20

2 WALL MOUNTED LEAFLET DISPENSER

Size	Capacity	Ref	Price
A4 Portrait	30mm	7780	£5.62
A5 Portrait	30mm	7783	£3.09
1/3A4 Portrait	30mm	7787	£2.02

3 FREESTANDING LEAFLET DISPENSER

Size	Capacity	Ref	Price
A4 Portrait	30mm	7704	£5.62
A5 Portrait	30mm	7705	£2.84
1/3A4 Portrait	30mm	7703	£2.22
Business card	18mm	7708	£1.18

4 FREESTANDING POSTER HOLDER

Size	Capacity	Ref	Price
A5 Portrait	3mm	7755	£1.78
A4 Portrait	3mm	7754	£3.25
A3 Portrait	3mm	7753	£8.58
A3 Landscape	3mm	7763	£11.29



7708 – business card freestanding dispenser

Crystal clear literature dispensers and poster holders. The dispensers will hold leaflets up to the capacity shown and the poster holders hold a single sheet of paper or card behind the clear plastic face. Both styles are available as free standing for counter top use or for wall mounting.

THREE SIDED POSTER HOLDER

A classic table poster holder in a triangle Toblerone shape. Will fit any A4 size folded print, displaying 3 DL size sides for offers, promotions, menus or specials. Supplied in a rigid clear acrylic. 215mm high.

Colour	Ref	Roll of 1000
Clear	7861	£7.16



DOUBLE SIDED T POSTER HOLDER

An ultra-slim protective disc holder, made of a semi-rigid plastic with Easy advertising with table poster holders in the classic T shape for double sided promotions. For A4 or A5 size prints and used for counters, tables or workspaces for offers, promotions, menus or specials. Supplied in a rigid clear acrylic.

Type	Size	Ref	Price
Clear	A5	7865	£2.78
Clear	A4	7864	£4.51



BANNER STANDS

ROLLER BANNER STANDS

Roller banners are increasingly accessible and easy to produce, you can create instant advertising and message exposure with any wide format printer and a simple banner stand. Our range of banner stands fit all situations and all of them are portable and easy to use.

Stand only, supplied without poster material or paper.

Product	Width	Ref	Price	+12	+24
Banner stand with snap rail	800mm	27101	£19.99	£16.49	£14.49
Banner stand with snap rail	850mm	27102	£20.55	£16.95	£15.21
Banner stand with adhesive rail	800mm	27103	£19.99	£16.49	£14.79
Banner stand with adhesive rail	850mm	27104	£20.55	£16.95	£15.21
Premium with snap rail	800mm	27105	£45.85	£37.83	£33.93
Premium with snap rail	850mm	27106	£46.40	£38.28	£34.33

**BUY 24 UNITS
SAVE 35%**



CD FOAM HOLDERS

A simple, fast CD fixing, these dots of high density foam can be stuck almost anywhere and a CD simply pushed on to the dot for an instant CD holder. Supplied on rolls of 1000 foam dots. 16mm diameter, 3mm thickness.

Colour	Ref	Roll of 1000
Black	7337	£13.83
White	7335	£13.83



CLAMSHELL CD/DVD CASE

An ultra-slim protective disc holder, made of a semi-rigid plastic with a simple click fastening. Less than one third the weight of a jewel case, this is ideal for mailing purposes as they are not brittle like usual CD cases.

Type	Ref	Pack 100	Pack 1000
Clear	7330	£26.29	£213.27



CD DIGI TRAYS

No	Type / colour	Ref	Pack 100	Pack 1000
1	Single black gloss	7302	£20.76	£121.45
2	Single clear DVD	7306	£23.90	£170.88

Rigid plastic trays to hold a CD or DVD for including in projects and documents. Available in two options.



CD HOLDERS

Lightweight adhesive plastic CD holders, simply peel off backing paper and apply to any surface, document or presentation. Nearly invisible adhesive for a completely transparent effect.

Colour	Ref	Pack 100	Pack 1000
Clear	7312	£17.52	£95.82
Black	7310	£17.52	£95.82
White	7311	£17.52	£95.82



CD SPIDERS

Classic adhesive CD spiders. Tough rigid plastic holders for any CD or DVD in a case, document or folder. Strong adhesive foam backing for permanent fixing to most surfaces.

Colour	Ref	Pack 100	Pack 1000
Clear	7332	£28.85	£150.54
Black	7333	£28.85	£150.54
White	7334	£28.85	£150.54



SHOWCARD RUDDER STRUTS

Classic cardboard rudder struts for creating quick posters and display materials. Supplied flat, they can be glued or taped to any promotional material and instantly assembled to create a stand for that material. Available in an unfinished grey pulp board or a white semi-gloss finish.

Height	Thickness	White	Pack 25	Pack 100	Pack 1000
90mm	1250mic	7709	-	£14.93	£89.98
140mm	1250mic	7714	-	£15.20	£91.14
190mm	1250mic	7719	-	£15.67	£94.18
240mm	1650mic	7724	-	£20.77	£126.58
290mm	1650mic	7729	-	£25.54	£156.96
340mm	1650mic	7734	-	£40.18	£250.13
390mm	1650mic	7739	-	£53.87	£337.22
490mm	1650mic	7749	£33.26	£97.27	£797.63
570mm	1650mic	7757	£39.80	£98.09	£820.35



MENU HOLDERS / CARD GRIPPERS

Clear PVC grippers to hold a card. The 75mm version has a strong adhesive foam tape on the underside while the 100mm version has a wider base for stability.

Product	Size	Ref	Pack 100	Pack 1000
Menu card gripper (adhesive)	75mm	5532	£33.81	£208.08
Wide menu card gripper	100mm	5537	£32.02	£259.30



PEN GRIPPERS

A range of handy adhesive pen grippers. Standard plastic for typical ballpoint pens, and a larger jumbo grip for bigger pens.

Type / material	Size	Ref	Pack 100	Pack 1000
Standard Plastic	13x11mm	7325	£17.71	£92.47
Jumbo Plastic	26x19mm	7324	£33.42	£280.65



SPRING WOBLERS

A sturdy metal and plastic wobbler fixing with a strong spring instead of a plastic arm.

Size	Ref	Pack 100	Pack 1000
35mm	7349	£21.72	£134.58

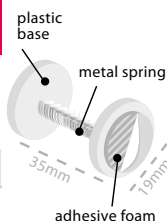

DISPLAY WOBLERS

Classic plastic wobbler arms to display promotional offers and messages. The adhesive on the wobblers sticks onto display material or card and the other end onto a wall or surface.

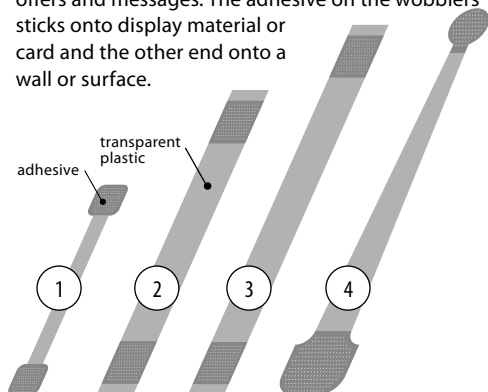

No	Size	Ref	Pack 100	Pack 1000	10+ packs of 1000
1	75mm x 10mm	7341	£6.92	£29.42	£17.65
2	150mm x 14mm	7343	£7.57	£31.15	£18.69
3	200mm x 14mm	7345	£7.79	£32.55	£19.53
4	200mm shaped	7348	£11.57	£51.26	£30.76

U SHAPE WOBLERS

A pre-creased plastic display U shaped wobbler to give a neat fixing.

Size	Ref	Pack 100	Pack 1000	10+ packs of 1000
75mm	7340	£15.68	£71.92	£43.15

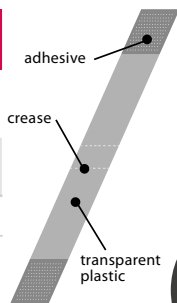

We'll PRICE MATCH or BEAT, speak to us now

ALUMINIUM WOBLERS

A flexible metal display wobbler that can hold heavier materials and be easily bent to the exact angle or shape required.

Size	Ref	Pack 100	Pack 1000
75mm	7360	£19.03	£117.34
150mm	7370	£29.90	£184.45



T SHAPE WOBLERS

Clear PVC shaped wobbler for use with shelf plastic strip packaging, plus an adhesive pad to fix your display card to.

Size	Ref	Pack 100	Pack 1000
140mm	7347	£18.49	£92.60



HANGING TABS / HEADER CARD TABS

Hanging tabs with adhesive strip for retail packaging use. The Euro tabs are 300 micron plastic supplied on rolls.

The hook and hole tabs are heavier duty 380 micron plastic supplied loose.

Product name	Size	Ref	Pack 100	Pack 1000
Euro tab	42x36mm	7350	-	£40.99
Hook tab	24x40mm	7355	£11.03	£55.17
Hole tab	25x33mm 8mm hole	7353	£9.91	£42.83

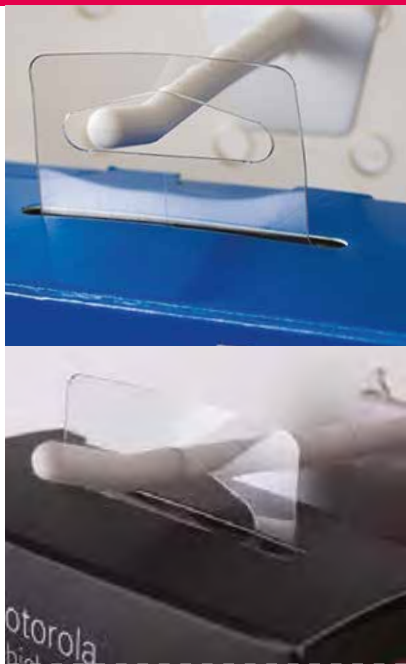
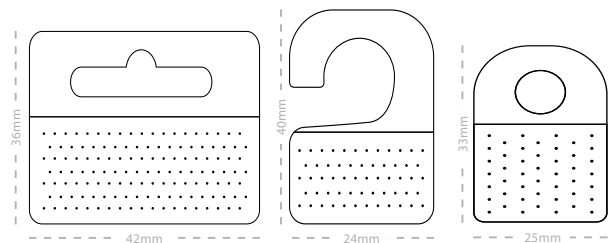

S-HOOK FIXINGS

Classic S shaped hooks for point of sale display and other fixing applications. Available in white plastic or metal wire material. Use for linking signage and displaying mounted materials.

Type	Size	Ref	Pack 100	Pack 1000
Plastic	55mm	5503	£16.76	£90.85
Metal	40mm	5501	£9.65	£55.93



C-HOOK FIXINGS

C shaped hooks for linking signage and use in point of sale and display hanging. Available in a solid white plastic or a metal wire hook.

Type	Size	Ref	Pack 100	Pack 1000
Plastic	40mm	5505	£15.68	£97.55
Metal	40mm	5507	£8.22	£31.80



Discover more information, blogs, videos and products online. You can call us Mon – Fri 8am – 5pm or browse and buy 24/7 at presco.eu.

WIRE CEILING CLIPS

Available in two sizes, these wire ceiling clips use a spring action to attach to ceiling T-grids.

Type	Size	Ref	Pack 100	Pack 1000
Metal	55mm	7315	£17.50	£74.58
Metal	80mm	7317	£15.65	£91.75



CEILING HANGER

A strong adhesive foam pad backing makes sure that you can safely hang different display items from this 20mm diameter hanger.

Type	Ref	Pack 100	Pack 1000
Plastic	7322	£12.92	£58.18



CEILING T-CLIP

This clever little hanger slides firmly onto a suspended ceiling grid.

Type	Ref	Pack 100	Pack 1000
Plastic	7321	£9.91	£37.44



HEAVY DUTY CEILING HANGER

30mm square base with a strong adhesive pad that has four times the adhesive area of the standard hanger, ensuring that heavier display work can be safely suspended.

Type	Ref	Pack 100	Pack 1000
Plastic	7323	£25.16	£152.70



MAGNETIC CEILING HANGER

If you need to hang a display from a metal surface or beam, this powerful magnet, encased in moulded plastic, will be ideal. Supports up to 1kg. Size: 15mm.

Type	Ref	Pack 100	Pack 1000
Plastic	5568	£79.60	£568.77



NYLON THREAD - 50M REEL

Ideal for use with signage and mobiles, this transparent nylon thread is supplied in wrist spools of 50 metres with a breaking strain of 5kg.

Type	Ref	Single	10+
Nylon	5525	£4.11	£2.30





We supply a vast range of other products and produce custom display products as well. Please **contact us** and we will do our best to help you.

DOUBLE ENDED HOOKS

Ideal for hanging signs, these double ended hooks come with a choice of three different sizes to suit your display.

Size	Ref	Pack 100	Pack 1000
100mm (4")	7319	£7.83	£41.54
150mm (6")	7313	£8.59	£39.40
300mm (12")	7314	£8.96	£44.78



EXTENDING DOUBLE ENDED HOOKS

A double ended hook with an untensioned spring in between for suspending and connecting signs. Simply stretch to the desired suspension height and let go! Stretches from 160mm to any length up to 1metre.

Size	Ref	Pack 100	Pack 1000
160mm – 1m	7320	£12.03	£50.94



WALL MOUNTED POSTER FRAMES

Aluminium snap frames for displaying posters and advertising materials. Mount to the wall with the supplied fixings and simply click your display material in and out as needed. Ideal for use in busy restaurant and service areas, in schools, hospitals and for educational purposes.

We can supply a wide range of other colours and sizes in addition to these stock frames.

Size	Ref	Price	10+
A4	7794	£6.84	£6.40
A3	7793	£9.18	£8.58
A2	7792	£13.21	£12.35

WANT MORE?
Call us for bulk prices



Order online 24/7 for **FAST** delivery presco.eu

STANDARD SUCTION CUPS



No	Diam. A	Diam. B	Ref	Pack 100	Pack 1000
1	22mm	7mm	7090	£8.22	£45.96
1	32mm	9mm	7092	£12.55	£67.92
1	50mm	16mm	7093	£26.16	£143.62

Clear plastic suction cups for attaching posters or display material to glass or polished surfaces. Available in 3 diameters depending on the size of your material.

SPECIAL SUCTION CUPS

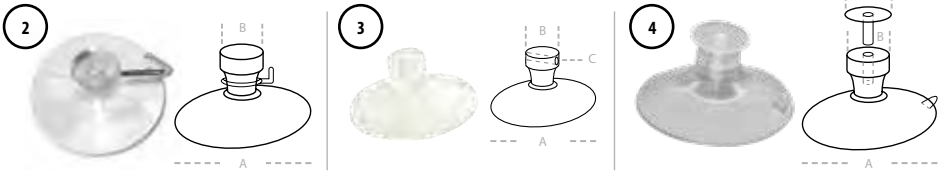

A range of special variations on the classic suction cup. Choose from cups with an additional hook, a hole through the fixing knurl, or a 2 part cup with a fixing 'thumbtack' pin.

No	Product	Diam. A	Diam. B	Diam. C	Ref	Pack 100	Pack 1000
2	With hook	40mm	14.7mm	-	7095	£19.74	£107.28
3	With hole	30mm	9.3mm	4.8mm	7091	£25.53	£148.17
4	Thumbtack	42mm	15mm	10mm	7096	£20.06	£112.20
4	Thumbtack	50mm	15mm	12mm	7097	£24.23	£137.76

SPECIALS

Our specials department can manufacture or source any custom product for you, give us a call on **01793 716300**.

+much, much more!
See pages 56-57

Some of our most popular specials are:

- ✓ Bespoke size pockets
- ✓ Custom elastic loops and cord
- ✓ Literature dispensers
- ✓ Hook & loop cut lengths
- ✓ Specialist tapes
- ✓ Printed lanyards
- ✓ POS fixings and fittings

Custom widths, colour, paired and cut to length

hook & loop



EYELETTING MACHINES

FOR SMALL EYELETS

1



2



3



1 HAND EYELETTER

Sturdy and simple hand tool to punch hole and close eyelets.

Ref	Price
4401	£28.69

2 EASI-EYE EYELETTER

Quick and easy semi-automatic eyeletting with one pull of the handle. It has a very deep throat of 130mm and a large hopper for the eyelets. Uses our Easi-Eye small eyelets.

Ref	Price
4420	£460.72

3 PRESKO 24 HEAVY DUTY EYELETTER

A very heavy duty semi-automatic eyeletter for small eyelets. It is the machine for handling regular or large quantities of eyeletting. Also available in electrically powered versions.

Ref	Price
4425	£983.65

SMALL EYELETS

Product	Compatible machines	Hole size	Pack size	Length	Brass	Price	Nickel	Price
V1	Hand eyeletter	4.7mm	500	3.5mm	4405	£21.20	4404	£21.20
V2	Hand eyeletter	4.7mm	500	4.5mm	4406	£21.20	4407	£21.20
No 02	Model 02	3.9mm	10,000	3.1mm	4410	£122.21	4409	£140.49
No 24	Model 24	4.5mm	10,000	3.3mm	4413	£68.78	4427	£68.78
No 25	Model 24	4.5mm	10,000	4mm	4416	£76.46	4426	£76.46
No 01 Bates	Bates	4.7mm	10,000	3.5mm	4428	£184.29	4430	£211.87
No 02 Bates	Bates	4.7mm	10,000	4.5mm	4429	£191.97	4431	£220.52
Easi-Eye	Easi-Eye	4.5mm	1,000	4mm	4418	£25.36	4422	£25.36
Easi-Eye	Easi-Eye	4.5mm	10,000	4mm	4418	£93.12	4422	£93.12
D7/JV2	Model D7	4.7mm	10,000	3mm	4411	£92.25	4412	£92.25



FOR LARGE EYELETS



4 HAND BANNER EYELETING TOOLS

The traditional tools, originally used for sailmaking, are a cost effective method of applying large eyelets to banners and other products. A hole does need to be punched in the material before applying the 2 part eyelets with this system.

Product	Type	Ref	Price
Closing tool set	No S4	4374	£54.83
Hole punch	No S4	4377	£24.98
Closing tool set	No S8	4389	£63.59
Hole punch	No S8	4392	£28.66

5 PRESKO HEAVY DUTY BANNER EYELETTER

This heavy duty banner eyeletting machine is well worth the extra cost for anyone regularly eyeletting banners or other work with large eyelets. The precisely engineered action makes banner eyeletting fast and simple for any quantity. Supplied without a die set. All the dies listed below will fit this machine.

Product	Type	Ref	Price
Banner Eyeletter	-	4399	£288.40
SPG Die Set	9.3mm	4393	£101.97
SPK Die Set	11.8mm	4394	£101.97
SPW Die Set	9.7mm	4395	£101.97
SPX Die Set	11.2mm	4396	£101.97
SPY Die Set	12.9mm	4390	£101.97



bannerEYE

True innovation in banner eyeletting.

A sturdy and simple machine for fixing plastic banner eyelets into materials, it can be used with plastic banner eyelets in black, white or clear.

bannerEYE is a new innovation in banner eyeletting, using heavy duty plastic eyelet sets to make a secure fastening that is stronger and quicker to press than standard metal banner eyelets.

Get rid of metal banner eyelet issues like rusty eyelets and flimsy fixings with this new system.

Ref	Price
4391	£212.21

BANNER EYELETS

Metal banner eyelets in nickel or brass, S4, S8 and all SPX sizes for a smart and durable finish on banners and posters. If you are not too sure which eyelet your machine takes we will be able to match up the correct item for you.



Product	Compatible machines	Hole size	Length	Brass	Pack 100	Pack 1000	Nickel	Pack 100	Pack 1000
SPG	Eyeletter with SPG Head	9.3mm	5.3mm	4340	£30.17	£142.76	4341	£34.72	£166.76
SPK	Eyeletter with SPK Head	11.8mm	5.8mm	4343	£36.21	£169.42	4344	£41.05	£179.07
SPW	Eyeletter with SPW Head	9.7mm	5.9mm	4398	£30.53	£135.17	4400	£32.42	£157.73
SPX	Eyeletter with SPX Head	11.2mm	6.2mm	4346	£39.63	£177.76	4347	£43.43	£197.67
SPY	Eyeletter with SPY Head	12.9mm	6.6mm	4349	£59.18	£257.41	4350	£66.19	£291.76
VL-70	Eyeletter with VL-70 head	15.5mm	7mm	-	-	-	4373	£22.17	£159.74
S4	S4 Hand Banner Tools	8.9mm	6.35mm	4370	£16.11	£99.39	4371	£18.60	£111.94
S8	S8 Hand Banner Tools	12.7mm	7.9mm	4385	£26.81	£210.35	4386	£29.80	£215.76

bannerEYE EYELETS

The eyelet sets are for use with the **bannerEYE** plastic eyelet press. The eyelets are self-piercing and punch a 13.5mm hole with a final finished internal diameter of 12mm. This is a specially strengthened heavy duty plastic with a very high strain level and will protect even the most demanding jobs. Black, White and Clear are stocked colours.

Colour	Ref	Pack 100	Pack 1000
Black	4330	£28.06	£153.87
White	4331	£28.45	£157.57
Clear	4339	£27.04	£153.48

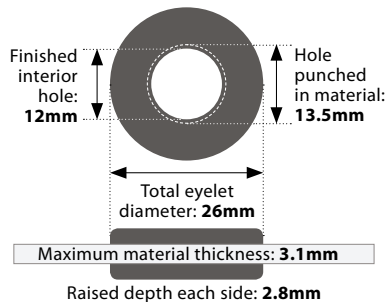

PLASTIC BANNER EYELETS

With an internal dimension of 13.5mm, our white plastic ratchet banner eyelets can be clipped together by hand. They require a pre-punched or drilled 15.5mm diameter hole.



Colour	Ref	Pack 100	Pack 1000
White	4397	£45.42	£338.51

HICKORY HAMMER

A real traditional engineer's hammer that we all need for many uses including machine set up, print finishing and assembly work.

Weight	Ref	Price
16oz.	4777	£10.40



STEEL RULERS

Length	Ref	Price
600mm	4458	£9.88
900mm	4459	£12.26



Virtually indestructible steel rulers with clearly marked metric and imperial measurements.

ANTI-STATIC BRUSHES

These incredible brushes dissipate static electricity and are invaluable to remove static when printing wide format plastic materials or to stop dust problems resulting from static. Just brush across the material to remove the static build up.

Length	Ref	Price
Small – 130mm	6132	£62.95
Large – 280mm	6134	£132.99



MEASURING CALLIPER

Electronic measuring callipers are incredibly accurate and measure up to 100th of a millimetre.

Size	Ref	Price
0-150mm	4455	£26.67



MARKER PENS

Standard marker pens have a bullet head to give a thick, black line. Each box contains 12 markers. The fine marker pens that write on most surfaces. Pack of 12.

Type	Ref	Price	5+
Standard - Permanent	4750	£15.10	£12.08
Fine - Permanent	4760	£15.10	£12.08



DRILLING

DRILL BITS

The most common drill bit style fitting. 85mm length with 50mm cutting depth to fit Babs, Citoborma, Corta, Foelmer, NFPE, Frewa, Kobold, Hang, Pescha, Uchida, Concorde, Stago-Zellar, Venus, Iram & Oslo drills. The tungsten coated grade versions are longer lasting and need sharpening less often, so they are ideal for large amounts of drilling. The Teflon coated drill bits create less friction and are particularly suited for laminated work. Note that the 3mm and 4mm drill bits only have a cutting depth of 30mm.



STANDARD FITTING

Length: **85mm**
Cutting depth: **50mm**

Size	Ref	Price
3mm	9030	£14.77
4mm	9040	£14.77
5mm	9050	£13.69
5.5mm	9055	£13.69
6mm	9060	£13.69
6.5mm	9065	£13.69
7mm	9070	£13.69
8mm	9080	£14.50
9mm	9090	£18.53
10mm	9100	£22.70

TUNGSTEN GRADE

Length: **85mm**
Cutting depth: **50mm**

Size	Ref	Price
4mm	9042	£36.28
5mm	9052	£34.10
6mm	9062	£34.10
7mm	9072	£34.10
8mm	9082	£34.83

TEFLON COATED

Length: **85mm**
Cutting depth: **50mm**

Size	Ref	Price
4mm	9240	£28.21
5mm	9250	£27.13
6mm	9260	£27.13
7mm	9270	£27.13
8mm	9280	£27.94



Please contact us for information on the electric paper drills we sell

The standard fitting with extra cutting depth for use with Iram drills and others that can take the longer drill bits. The tungsten coated grade version are longer lasting and need sharpening less often, so they are ideal for large amounts of drilling. The Teflon coated drill bits create less friction and are particularly suited for laminated work.



STANDARD FITTING X-LONG (IRAM)

Length: **100mm**
Cutting depth: **65mm**

Size	Ref	Price
4mm	9440	£27.67
5mm	9450	£23.64
5.5mm	9455	£23.64
6mm	9460	£23.64
6.5mm	9465	£23.64
7mm	9470	£23.64
8mm	9480	£29.02
9mm	9490	£33.74
10mm	9500	£33.74

X-LONG TUNGSTEN (IRAM)

Length: **100mm**
Cutting depth: **65mm**

Size	Ref	Price
4mm	9442	£46.69
5mm	9452	£44.16
6mm	9462	£44.16
7mm	9472	£45.32
8mm	9482	£52.25

X-LONG TEFLON (IRAM)

Length: **100mm**
Cutting depth: **65mm**

Size	Ref	Price
4mm	9640	£41.12
5mm	9650	£37.08
6mm	9660	£37.08
7mm	9670	£37.08
8mm	9680	£44.81



DRILL BITS

For 1013,
1015 and
Iram filofax.



LIHIT MAJOR

Length: **82mm**
Cutting depth: **50mm**

Size	Ref	Price
3mm	9830	£24.18
4mm	9840	£24.18
5mm	9850	£22.49
5.5mm	9855	£22.49
6mm	9860	£22.49
6.5mm	9865	£22.49
7mm	9870	£22.49
8mm	9880	£22.49

NOTE: 3 & 4mm drill bits have reduced cutting depth.

For Lihit
Autopunch
2001 and
Mark II.



LIHIT MINOR

Length: **52mm**
Cutting depth: **25mm**

Size	Ref	Price
3mm	9903	£22.49
4mm	9904	£22.49
5mm	9905	£21.88
5.5mm	9905.5	£21.88
6mm	9906	£21.88
6.5mm	9906.5	£21.88
7mm	9907	£21.88
8mm	9908	£21.88

NOTE: 3 & 4mm drill bits have reduced cutting depth.

For Soag,
Kaynor and
Nyren.



SOAG

Length: **90mm**
Cutting depth: **50mm**

Size	Ref	Price
3mm	9913	£28.61
4mm	9914	£27.67
5mm	9915	£26.60
6mm	9916	£24.49
6.5mm	9916.5	£26.60
7mm	9917	£31.17
8mm	9918	£31.17

NOTE: 3 & 4mm drill bits have reduced cutting depth.

For Funditor,
Challenge
and Spinnit.



FUNDITOR/ CHALLENGE

Length: **83mm**
Cutting depth: **50mm**

Size	Ref	Price
3mm	9923	£24.84
4mm	9924	£22.70
5mm	9925	£22.70
6mm	9926	£22.70
7mm	9927	£22.70
8mm	9928	£23.42
10mm	9930	£28.94

NOTE: 3 & 4mm drill bits have reduced cutting depth.



FILEPECKER DRILLBIT

Length: **95mm**
Cutting depth: **65mm**

Size	Ref	Price
3mm	9703	£29.50
4mm	9704	£27.08
5mm	9705	£27.08
6mm	9706	£27.08
7mm	9707	£27.08
8mm	9708	£27.08

NOTE: 3 & 4mm drill bits have reduced cutting depth.

MORE ONLINE AT **PRESCO.EU**



All drill bits stocked for
IRAM, LIHIT, SOAG and
more at **presco.eu**

DRILLING ACCESSORIES

The powerful, clean air spray easily disposes of waste and dirt particles that can compromise the effectiveness of your machine or IT equipment. Waxing paper is used to reduce friction when drilling paper. Silicone spray has many uses as a clean lubricant and to reduce friction, such as on the bed of guillotines when moving piles of paper.

Product	Ref	Price
Air duster	4901	£11.68
Silicone spray	4900	£9.83
Waxing paper A4 (10 sheets)	4904	£28.98
Waxing paper A5 (10 sheets)	4905	£16.22
Drill Bit (3-10mm) Sharpener with Whetstone Block	4910	£57.86



CUTTING STICKS/DISCS FOR DRILLING

Length	Width / diam	Thickness	Compatible model	Ref	Pack 10
Disc	34mm diam.	2mm	Citoborma	4920	£48.25
Disc	40mm diam.	3mm	Citoborma	4918	£55.32
370mm	48mm	3mm	Citoborma	4922	£70.08
435mm	40mm	3mm	Citoborma	4927	£92.67
500mm	40mm	3mm	Citoborma	4925	£92.67
250mm	25mm	5mm	Iram	4930	£58.35
290mm	40mm	3mm	Uchida	4932	£55.72



A range of common cutting sticks and discs for drilling machines. Supplied in packs of 10, if you need to check more information on these visit presco.eu or contact us for advice.

GUILLOTINE STICKS

Length	Width	Thickness	Compatible model	Ref	Pack 10
453	14	14	Ideal 3905	4002	£31.58
570	14	14	Ideal 4205, 4215	4003	£104.58
570	14	14	Ideal 4700, 4810, 4850	4000	£40.60
645	14	14	Ideal 525, 5221, 5222	4001	£45.00
765	14	14	Ideal 6550	4005	£50.94
885	14	14	Ideal 7221	4006	£73.87
395	14	14	Dahl	4025	£30.70
770	10	4.5	Polar 76	4013	£34.00
910	10	4.5	Polar 90	4010	£40.60
930	10	4.5	Polar 92	4011	£40.60
1160	10	4.5	Polar 115	4012	£42.36



JOGGER BLOCKS

An essential for accurate guillotine work. These are far more than a block of wood – they are precision engineered nylon with magnetic inserts to ensure perfect knocking up of paper to be guillotined.

Product	Ref	Price
75x300mm	4107	£78.00
120x300mm	4109	£101.10

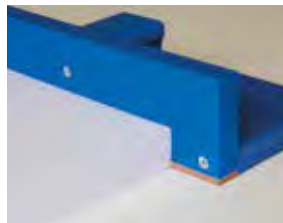

GUILLOTINE BLADES

Original highest quality German-made replacement guillotine blades as supplied with new Ideal guillotines. Available in Standard (Solingen) Steel or High Speed Steel grades. Our premium HSS blades are harder, will hold sharp edges longer and are suited for heavy use environments.



More options available, call for details

Description	Standard Steel	Price	High Speed Steel	Price
Ideal Guillotine Blade 3905/3915	4121	£99.07	4140	£135.00
Ideal Guillotine Blade 4205/4215	4122	£147.08	4141	£198.43
Ideal Guillotine Blade 4700/4705/4810/4850/46E	4123	£201.16	4142	£220.78
Ideal Guillotine Blade 5220/5221/5222	4124	£201.26	4143	£244.16
Ideal Guillotine Blade 6550	4125	£273.62	4144	£324.68
Ideal Guillotine Blade 7228	4126	£270.10	4145	£310.00
Ideal Guillotine Blade 4305/4315/4350	4127	£165.35	4146	£213.00
Ideal Guillotine Blade 525 5210/5250	4128	£221.00	4147	£285.71
EBA Guillotine Blade 430	4120	£133.00	4134	£134.20
EBA Guillotine Blade 460	4129	£143.00	4135	£197.00
EBA Guillotine Blade 480	4130	£219.00	4136	£262.00
EBA Guillotine Blade 520/550	4131	£230.36	4137	£285.71
EBA Guillotine Blade 660	4132	£289.45	4138	£349.00
EBA Guillotine Blade 710/720	4133	£320.00	4139	£376.62

MAGNETIC CLAMP PADS

Magnetic clamp pads for paper cutting guillotines take away the problem of unsightly markings from the metal hydraulic clamp. Particularly beneficial when cutting laminated stock or carbon papers, NCR or delicate stocks. Made from a 2mm magnetic rubberised layer and a 5mm high density foam, these pads provide the cushioning to cope with almost every material being cut, and protect the guillotine blade as well. Supplied in a pack of 2, will stick to metal surfaces of your guillotine for easy access.

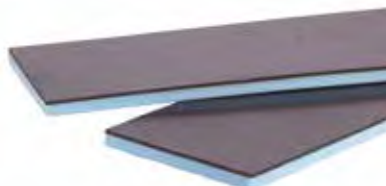

Product	Ref	Price
380x76x7mm	4105	£48.70

STAPLES

SEE
ONLINE
for full range
of staples &
machines



1 RAPID

Type	Pack size	Ref	Price
9/8	5000	0208	£9.62
9/10	5000	0210	£10.73
9/12	5000	0212	£10.38
9/14	5000	0214	£16.24
9/17	1000	0217	£5.09
9/20	1000	0220	£6.04
9/24	1000	0224	£6.64
26/6	5000	0226	£2.44
44/6	5000	0246	£5.31
44/8	5000	0248	£6.04
66/6	5000	0266	£4.95
66/7	5000	0267	£6.02
66/8	5000	0268	£7.04
66/6 Ri	5000	0270	£64.08
5050E	5000	0272	£31.87
DUAX	1000	0275	£11.22
5080E	5000	0276	£35.71

2 NAGEL

Type	Pack size	Ref	Price
24/6	5000	4521	£4.65
24/8	5000	4522	£9.00
24/10s	5000	4523	£19.50
24/13s	5000	4524	£23.27
24/15s	5000	4525	£25.64
24/18s	5000	4526	£31.39
24/20s	1000	4527	£7.98
24/6 Ri	5000	4540	£27.43
24/8 Ri	5000	4541	£29.70
26/6	5000	4531	£4.39
26/8	5000	4532	£8.71
26/8s	5000	4533	£16.35
26/6 Ri	5000	4544	£28.81
50/6	5000	4551	£13.78
50/8	5000	4552	£17.22
50/10	5000	4553	£18.15
50/12	5000	4554	£22.68
50/15	5000	4555	£25.09
50/18	5000	4556	£31.43
50/20	5000	4557	£36.82
50/23	1000	4558	£14.27
50/26	1000	4559	£15.03
50/30	1000	4560	£19.00

3 STAGO

Type	Pack size	Ref	Price
24/6*	5000	4521	£4.65
64/6	5000	4600	£28.95
64/8	5000	4601	£31.95
64/10s	5000	4602	£46.38
64/12s	5000	4603	£49.38
64/15s	5000	4604	£69.73
64/17s	5000	4605	£78.45
64/20s	5000	4606	£88.72
70/6	5000	4590	£44.30
70/8	5000	4591	£47.66
70/10	5000	4592	£51.20
70//12s	5000	4593	£71.55
70/15s	5000	4594	£80.27
70/18s	5000	4595	£88.98
70/20s	5000	4596	£93.35
70/22s	5000	4597	£99.17

* Nagel staples – equivalent to Stago.



Find stapling
machines
online at
presco.eu

**20%
DISCOUNT**
when buying
20+ boxes

4 PLOCKMATIC

Type	Pack size	Ref	Price
36/40	10,000	4567	£48.61
60/80	5000	4568	£16.78
88/91	5000	4569	£14.03

5 DUPLO / REXEL / SWINGLINE / PLOCKMATIC

Type	Pack size	Ref	Price
Cartridge	5000	4569	£14.03



6 RAPID (ETONA COMPATIBLE)

Type	Pack size	Ref	Price
23/6	1000	4501	£2.80
23/8	1000	4502	£3.04
23/10	1000	4503	£3.24
23/14	1000	4505	£3.76
23/15	1000	4507	£3.80
23/17	1000	4509	£10.64
23/20	1000	4511	£10.76
23/24	1000	4512	£11.92

WHAT SIZE STAPLES DO YOU NEED?

The first number of the 2 part staple type is the wire gauge and the second number refers to the length of the 'legs'. The leg length must be at least 3mm more than the thickness to be stapled. Check your instructions to find the maximum staple size your machine can use.

STAPLING MACHINES

RAPID 106 SADDLE STAPLER

Outstanding stapling machine that can be used for both saddle (booklet) stapling or pad stapling. These machines have changeable stapling heads that can be replaced for repair or to use other staples, including loop staples.

The machine is sold as a single machine or a twin rig set. Up to 4 machines can be used together using linking cables for multi-head stapling. Compatible with Rapid Staples 66/6, 66/7 and 66/8.

Model	Ref	Price
-------	-----	-------

Rapid 106E with foot pedal	0106	£519.03
----------------------------	-------------	---------

Rapid 106E Twin Rig with foot pedal	0109	£1,110.37
-------------------------------------	-------------	-----------



LONGARM RAPID STAPLER

Key features:

- Long reach up to 400mm
- For booklet or pad stapling
- All-steel construction
- Compatible with Rapid Staples 66/6 and 66/8

Model	Ref	Price
-------	-----	-------

Rapid 12/16	0112	£58.93
-------------	-------------	--------



RAPID PAD STAPLER

Key features:

- Up to 210 sheets
- Leverage mechanism for effortless operation
- Super heavy duty stapler
- Compatible with Rapid Staples 9/8 – 9/24

Model	Ref	Price
-------	-----	-------

Rapid HD210	0150	£87.24
-------------	-------------	--------



STITCHING WIRE

Gauge Type	m/kg approx	Approx m per 2.5 spool	Metal Type	Ref	Price	Price 8+
0.46mm Round	760	1900	Standard	4846	£16.00	£12.80
0.50mm Round	640	1600	Standard	4850	£15.56	£12.45
0.55mm Round	530	1325	Standard	4855	£14.96	£11.97
0.55mm Round	530	1325	Hardened	4857	£17.36	£13.89
0.55mm Round	530	1325	Black Coated	4865	£34.80	£27.84
0.6mm Round	440	1100	Standard	4860	£14.76	£11.81
0.8 x 0.55mm Flat	340	850	Standard	4808	£16.46	£13.17
0.8 x 0.55mm Flat	340	850	Hardened	4828	£19.45	£15.56
0.9 x 0.55mm Flat	270	675	Standard	4809	£16.06	£12.85
0.9 x 0.55mm Flat	270	675	Hardened	4829	£18.89	£15.12
1.0 x 0.8mm Flat	180	450	Standard	4818	£15.80	£12.64
1.0 x 0.8mm Flat	180	450	Hardened	4820	£18.56	£14.85

NEW black coated wire available



Steel stitching wire spools available in a standard or specially hardened steel. Pack size: 2.5kg reel.

New nylon coated black stitching wire now available from stock, speak to us for other custom enquiries.

3 IN 1 PUNCH

This clever desktop tool will punch a single hole, a slot or cut a 4mm radius corner by simply turning a dial to select.

Ref	Price
4454	£34.86



EURO SLOT PUNCH

Sturdy and durable, the euro slot punch will punch a standard 32mm euroslot into a wide range of card, plastic and ID materials with ease.

Ref	Price
4473	£20.27



HAND ROUND CORNERER

Handy round corner cutter for short run work.

Corner Radius	Ref	Price
5mm	4453	£14.65
10mm	4456	£12.26



ROUND CORNERING MACHINE

One of our most popular desktop tools, the corner cutting machine is sturdy, simple to use and is supplied with a 6mm corner die. Ideal for most paper stock thick or thin up to approx 9mm stacks and will also cut through single sheets of foamboard, die bond and laminates. Other dies and accessories can be very quickly fitted.



Product	Ref	Price	Additional die type	Ref	Price
Machine	4440	£93.88	Calendar thumbcut	4441	£20.55
Cutting discs (5)	4448	£8.11	10mm radius round corner	4445	£20.55
Back-stop set (use with 4441)	4450	£28.98	Chamfer cut corner	4449	£20.55
			6mm radius round corner	4444	£20.55
			3.5mm radius round corner	4443	£20.55

DIFFERENCE BETWEEN DIE TYPES EXPLAINED



Calendar thumbcut



10mm radius round corner die.



Chamfer cut corner



6mm radius round corner die.



3.5mm radius round corner die.

CREASING THIMBLETTES

Unique rubber thimblettes with built in rollers for precise and simple hand creasing. Pack of 2 contains one large and one small thimblette.

Product	Ref	Price
Thimblettes	4985	£6.79



FOLDING BONES

Traditional real bone and plastic folding bones give a sharp crease when hand folding and have become very popular again with the growth of short run digital printing.

Product	Ref	Price
Genuine bone 6"	4957	£6.99
Plastic 8"	4958	£5.49



MANUAL CREASER

Key features:

- Max. width up to 320mm
- Paper weight up to 400gsm
- Crease width 1 or 1.5mm

Product	Ref	Price
KSL 320	0870	£421.00



KNIVES & CUTTING

**BEST
SELLER**

SCALPEL & BLADES



Super sharp surgical scalpels have long been used in the graphics industry for precision cutting.

Product	Pack size	Ref	Price
Scalpel handle	1	4954	£15.36
Retractable scalpel handle	1	4953	£17.03
Spare blades 10A	100	4955	£28.01
Blade Remover	1	4949	£5.95



Genuine **Swann Morton** handles and blades, world leaders in quality and precision.

SELF RETRACTING KNIFE & BLADES

A 'Stanley' type knife with a difference – the blade automatically retracts after use. A brilliant safety innovation to reduce the risk of accidents. Uses standard disposable blades.

Product	Pack size	Ref	Price
Knife	1	4703	£11.58
Spare blades	10	4941	£3.79



STANDARD KNIFE & BLADES

The all-time favourite retractable style knife made famous by Stanley. Uses standard blades.

Product	Pack size	Ref	Price
Knife	1	4940	£8.92
Spare blades	10	4941	£3.79



HAVE YOU USED OUR WEBSITE?

Order online 24/7 for
FAST delivery **presco.eu**

SNAP-OFF KNIFE & BLADES

Product	Pack size	Ref	Price
Standard Snap-off Knife	1	4944	£8.33
Standard Spare blades	10	4945	£7.46
Mini Snap-off Knife	1	4707	£5.34
Mini Spare blades	10	4709	£5.68

Ergonomically designed and retractable knives that use snap off blades. Available in two sizes, standard packaging knife size or a compact mini version.



HAND PERFORATOR

Product	Pack size	Ref	Price
Perforator	1	4950	£12.98
Spare blades	2	4951	£7.25

Easy short run perforating with no time wasted on setting up machines.



CUTTING MATS

Size	Colour	Ref	Price
A4	Green	4890	£10.00
A3	Green	4892	£15.47
A3	Clear	4893	£26.07
A2	Green	4894	£28.12
A2	Clear	4895	£36.09
A1	Green	4896	£50.94
A1	Clear	4897	£54.51
A0	Green	4898	£122.53

The self-healing surface makes our cutting mats the first choice for long-lasting trimming work. Sturdy, durable and non-slip, these mats also have printed guide lines.

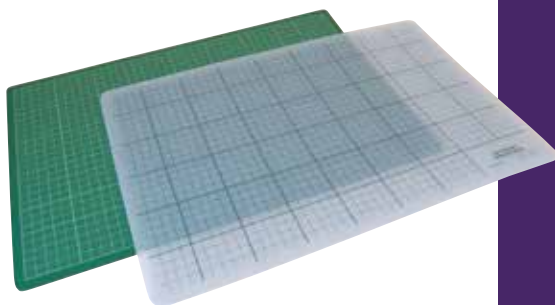

THIMBLETTES

Size	Ref	Pack 12
00 - Small	4981	£4.33
1 - Medium	4982	£4.33
2 - Medium	4983	£4.64
3 - Large	4984	£4.64

Flexible rubber thimblettes are ideal for ensuring a sure grip when hand finishing and also have ventilation holes for added comfort.



ROTARY TRIMMERS

Models	Cut length	Ref	Price
A4 Trimmer	360mm	0872	£80.84
A3 Trimmer	480mm	0875	£119.58
A2 Trimmer	670mm	0877	£145.72
A1 Trimmer with stand	960mm	0879	£283.84
A0 Trimmer with stand	1300mm	0880	£336.80
1.5 metre trimmer	1500mm	0884	£489.68
2 metre trimmer	2000mm	0886	£791.64

These professional rotary trimmers are designed for high volume usage. Safe and easy to use, they provide accurate trimming of paper, card and laminated work.

- Attractive silver and black finish
- Long-life self sharpening blade
- Ergonomic moulded rubber cutting head gives maximum comfort when trimming
- Automatic clamp holds items to be cut firmly in position
- Adjustable back stop for accurate alignment
- Printed base showing paper size guides
- Can be wall mounted for storage
- Manufactured to BS5498 ensuring maximum safety



SMARTCUT

Cuts, scores and perforates! As well as being an excellent desktop trimmer, the Smartcut can also score, perforate or do a wavy-line cut, all at the turn of a dial.

Models	Ref	Price
SmartCut A4	4965	£103.06
SmartCut A3	4966	£123.47

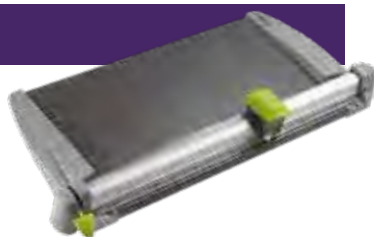

SPECIALS

Our specials department can manufacture or source any custom product for you, give us a call on **01793 716300**.

+much,
much more!
See pages
56-57

Some of our most popular specials are:

- Bespoke size pockets
- Custom elastic loops and cord
- Literature dispensers
- Hook & loop cut lengths
- Specialist tapes
- Printed lanyards
- POS fixings and fittings

Custom widths, colour, paired and cut to length

hook & loop



PACKAGING, BAG AND BOX SOLUTIONS

GREETINGS CARD ENVELOPES

Size (mm)	Ref	Pack 1000
120x165 + flap	1372	£55.28
170x230 + flap	1376	£61.84
229x305 + flap	1379	£104.22

Crystal clear wallets made from a thin 'cellophane' type material as commonly used for greetings cards. They have a flap with peel and seal adhesive. A smart way of presenting printed work.



POLY MAILING BAGS

Size (mm)	Ref	Pack 1000
C5 - 165x230 + flap	1325	£48.65
C4 - 230x305 + flap	1324	£64.86

Clear self-sealing polythene mailer bags are ideal packaging for catalogues and brochures. 30 micron thickness.

Supplied in handy header blocks which are perforated for easy detaching. Adhesive peel and seal strip completes the job. C3 size available for large quantities.



GRIP SEAL BAGS

Size (mm)	Ref	Pack 1000
140x140	1316	£25.16
150x230 (A5)	1315	£53.27
230x325 (A4)	1314	£86.36
330x445 (A3)	1313	£158.00

Polythene bags with an airtight grip seal closer. Ideal for sending samples, packing sets of components, or protecting printed work from moisture. Other sizes are available to order.



DOCUMENT ENCLOSED WALLETS

Size (mm)	Ref	Pack 1000
A7	1307	£25.96
A6	1306	£33.62
A5	1305	£68.04

Sturdy adhesive backed wallets for fixing paperwork to parcels. The wallets are oversized to take the paper sizes shown and all sizes are printed with 'Documents Enclosed'.





Interested in new plastic-free and environmentally solutions?

We're investing all the time in offering sustainable alternatives to plastic products and more and more of our items are now recyclable. From cardboard business card boxes to plastic-free binding covers, please speak to us for quotes and information.



CALL US FOR QUOTES AND MORE INFORMATION

EASYBOX WHITE CARDBOARD BUSINESS CARD BOX

Smart and eco-friendly packaging for business cards. Fit a 70mm deep stack of cards in an upright landscape position. Takes from 100 - 250 cards depending on the stock and thickness. Comes in pack of 250 boxes.

They come pre-made, simply pop them open, fill with cards and close the lid. Dimensions of internal capacity: Width 87mm, Depth 70mm, Box Height 60mm. External 89mm x 73mm x 62mm. Card thickness is 590 micron, approx 500 gsm card. **Ask us for a free sample today.**



Type	Colour	Internal dimensions	Ref	Pack 250	4+
Card	White	87x70x60mm	6584	£44.75	£38.04



CARDBOARD BUSINESS CARD BOXES TWO PART WHITE

Semi-gloss white card business card boxes in a smooth rigid cardboard, with a base box and a lid. Supplied flat pack for self-assembly.

Type	Colour	Internal dimensions	Ref	Pack 500
Card	White	90x65x34-50mm	6583	£96.36



**BUSINESS CARD/
COMP SLIP BOXES**

These durable, rigid clear boxes look great when supplying printed work to customers and are a practical way of storing and protecting business cards or compliment slips. Made from recyclable polypropylene.



Type	Dimensions	Capacity	Ref	Pack 100	Pack 125	Pack 250	Pack 500
Business card	93x58mm	34mm	7800	£22.17	-	£44.50	-
Double depth business card	96x58mm	67mm	7801	-	£55.56	-	£191.60
Compliment slip	222x111mm	55mm	7802	£77.86	-	-	£328.61

SLIMLINE POSTAL BUSINESS CARD BOXES



An innovative new way of sending out business cards in the post, classed as a small packet instead of a parcel. Hard rigid plastic securely protects and presents the business cards, with 2 or 4 compartment options. Each compartment holds approx 50 cards and they are available in white or clear plastic. 2 part box – approx 100 cards, 4 part box – approx 200 cards.

Type	Colour	Capacity	Ref	Pack quantity	Price
2 part	White	100x130x24mm	7806	210	£56.86
2 part	Clear	100x130x24mm	7807	210	£56.86
4 part	White	200x130x24mm	7804	100	£41.80
4 part	Clear	200x130x24mm	7805	100	£41.80

PAPER REAM BOXES

These boxes are made from sturdy white card and take 500 sheets of A5 or A4 paper. They are supplied flat packed for easy storage.

Size in mm	Ref	Pack 50	Pack 100	Pack 500
A5	6587	-	£75.71	£309.00
A4	6588	£29.66	-	£213.37

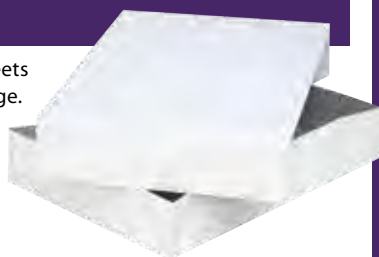

RUBBER BANDS

Size	Dimensions	Pack size	Ref	1 box	20 box carton
14	50x1.5mm	1300	6283	£4.35	£63.70
18	80x1.5mm	1000	6285	£4.35	£63.70
32	80x3mm	600	6287	£4.35	£63.70
33	90x3mm	500	6288	£4.35	£63.70
35	111x3mm	400	6289	£4.35	£63.70
38	150x3mm	300	6291	£4.35	£63.70

We stock a wide range of rubber bands for print finishing and packing in 454 gram (1lb) packs. Our standard bands are in the natural rubber colour.



SHRINKWRAP FILM

PVC FILM 25 micron shrink wrapping film which works on almost all shrink wrapping machines. Roll length 450m.

Dimensions	Ref	Price
300/600mm	6230	£39.36
350/700mm	6235	£44.27
400/800mm	6240	£47.84
475/950mm	6245	£52.55
500/1000mm	6250	£57.09
600/1200mm	6260	£71.40

POLYOLEFIN FILM A stronger, less brittle and static-free film. Not all machines can use this film. Thickness is 15 micron and roll length 1335m.

Dimensions	Ref	Price
300/600mm	6232	£81.66
350/700mm	6237	£95.05
400/800mm	6242	£108.46
450/900mm	6247	£121.85
500/1000mm	6252	£129.56
600/1200mm	6262	£162.13



All of these films are centrefold with the two widths being the roll width and unfolded width.

PALLET STRETCH WRAP

Type	Size	Thickness	Ref	Price
Standard Black	500mmx220m	21mic	1340	£14.00
Standard Clear	400mm x 220m	17mic	1338	£14.00
Stretch Wrap Dispenser	-	-	1330	£32.50
Handy Wrap Dispenser	-	-	1333	£3.60
Handy Wrap Roll	100mmx150m	20mic	1335	£2.78

Quality stretch wrap film available in the hand application rolls and jumbo size rolls for machine application. The black film is increasingly popular for greater security.



1330 – Stretch wrap dispenser



1333 – Handy wrap dispenser



IDENTITY

We'll **PRICE MATCH** or **BEAT**, speak to us now



PREMIUM PLAIN LANYARDS

Our premium range lanyards are of the highest quality with metal 'egg-hook' fittings and are intended for regular longer term use. They have a safety breakaway clip included. 10mm width braid.



Colour	Ref	Pack 100	Pack 1000
Blue	7002	£47.68	£353.68
Orange	7006	£47.68	£353.68
Black	7000	£47.68	£353.68
Green	7004	£47.68	£353.68
Red	7003	£47.68	£353.68
White	7001	£47.68	£353.68

ECONOMY PLAIN LANYARDS

The economy range lanyards are intended for events or visitor use where the use is short term. They have plastic fittings and breakaway safety clip.

Colour	Ref	Pack 100	Pack 1000
Black	8650	£27.80	£208.27
White	8651	£27.80	£208.27
Royal Blue	8652	£27.80	£208.27
Red	8653	£27.80	£208.27
Green	8654	£27.80	£208.27
Yellow	8655	£27.80	£208.27
Orange	8656	£27.80	£208.27
Grey	8658	£27.80	£208.27
Navy Blue	8662	£27.80	£208.27



CUSTOM PRINTED LANYARDS

Custom printed lanyards are essential branding for many events and organisations. They have great promotional value, look professional and are an ideal way to give exposure to sponsors.

Your logo or message is printed on a high quality silk ribbon. View prices below and contact us to order and discuss your requirements. Upon receipt of artwork we can usually manufacture this product within 3-5 days, for larger quantities this will be up to two weeks.

Width	Ref	50+	100+	300+	500+
15mm	BPL15	£5.00	£2.58	£2.20	£1.92
20mm	BPL20	£5.00	£2.44	£2.20	£1.98
25mm	BPL25	£5.00	£2.94	£2.70	£2.48



More information can be found online at presco.eu



PREMIUM ID CARD LAMINATOR

A heavy duty machine that is ideal for use on reception desks or security points where identity cards need to be laminated but desk space is limited. Base size is just 22cm x 16cm. Laminates all thicknesses of pouch up to A6 size

Product	Ref	Price
ID Laminator	0504	£134.85



ID SLOT PUNCH

A hand punch for quickly punching a standard ID slot in any laminated card or document to take a lanyard or other fixing clip.

Slot size	Ref	Price
13x4mm	7179	£28.96



LEVER CLIP & STRAP

Sturdy locking lever clip with plastic inserts to protect fabric from damage. For use with slot punched identity cards or card holders.

Clip size	Ref	Pack 100	Pack 1000
29x14mm	7101	£19.68	£157.25



CROCODILE CLIP & STRAP

Simple crocodile clip and strap fitting for use with slot punched identity cards or card holders.

Clip size	Ref	Pack 100	Pack 1000
21x11mm	7102	£17.30	£137.35



COMBINED PIN & CLIP

A badge fitting with self-adhesive pad for sticking onto an identity badge and the options of crocodile clip or safety pin to fix to clothing.

Clip size	Ref	Pack 100	Pack 1000
22x12mm	7105	£20.76	£165.25



MAGNETIC BADGE HOLDERS

A unique fitting to avoid any damage to clothing when wearing a badge regularly. One part has self-adhesive backing to fix to the badge and the other part goes the other side of the clothing.

Clip size	Ref	Pack 100	Pack 500
45x12mm	7109	£72.68	£296.84



ADHESIVE BROOCH PIN

Self-adhesive badge fitting with a standard brooch pin mechanism.

Adhesive square size	Ref	Pack 100	Pack 1000
20x20mm	7107	£30.28	£241.50



NECKLACE BALL CHAIN

760mm Necklace chains in bright nickel or white plastic for use with identity badges or pockets.

Type	Length	Ref	Pack 100	Pack 1000
Nickel	760mm	7127	£48.32	£285.67
White plastic	760mm	7130	£30.85	£192.61



NICKEL BALL CHAIN

Nickel ball chain in cut lengths and supplied open with a connector fixed one end. Ideal for fixing identity badges or labels to equipment and luggage.

Product	Ref	Pack 100	Pack 1000
100mm	7125	£15.97	£97.85
150mm	7126	£18.54	£114.23
230mm	7129	£33.73	£185.40



Many more products can be found online at presco.eu

SPLIT/KEY RING

Classic tension key ring for use in tagging and security applications.

Diameter	Ref	Pack 100	Pack 1000
25mm	7142	£10.71	£58.89



LUGGAGE TAG STRAP

A black buckled strap for fixing slot punched badges or card holders to luggage.

Overall length	Ref	Pack 100	Pack 1000
158mm	7120	£30.28	£241.50



LUGGAGE TAG LOOP

A sturdy clear plastic loop for fixing identity labels to luggage

Length	Ref	Pack 100	Pack 1000
150mm	7121	£9.73	£69.22



PIN BADGE HOLDER

Sleeve of pre-formed and semi-rigid PVC that a card can be inserted into, with a brooch pin fitting.

Card size	Ref	Pack 50	Pack 500
90x57mm	7165	£12.36	£93.24

PIN & CLIP BADGE HOLDER

A similar product to the Pin Badge holder but with a combined crocodile clip and safety pin fitting.

Card size	Ref	Pack 50	Pack 500
75x40mm - card insert included	7166	£16.49	£93.24
90 x 57mm - card not included	7167	£16.49	£108.72

We'll **PRICE MATCH** or **BEAT**, speak to us now

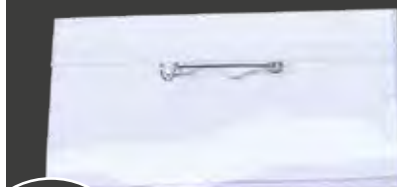

CLEAR PVC HOLDERS

Product	Slot	Type	Size	Ref	Pack 100	Pack 1000
Standard	Long edge	Landscape	95x65mm	7150	£22.72	£187.59
Standard	Short edge	Portrait	60x90mm	7155	£18.27	£157.07
Standard	Short edge	Portrait	80x98mm	7151	£22.72	£181.35
Oversized	Long edge	Landscape	98x80mm	7152	£23.62	£187.70
A6	Short edge	Portrait	105x148mm	7154	£42.89	£346.62



Flexible PVC card holders with a slot and holes for use with lanyards or other identity fittings.

RIGID CARD HOLDERS



These rigid card holders take standard credit card size identity cards (86x54mm). They have a slot and holes for use with lanyards or other identity fittings.

Type	Ref	Pack 100	Pack 1000	Colour	Portrait	Landscape
Open faced landscape – Clear	8677	£14.76	£106.80	Black	8680	8670
Open faced landscape – Colour	See right	£14.76	£106.80	White	8681	8671
Open faced portrait – Clear	8687	£16.17	£113.40	Blue	8682	8672
Open faced portrait – Colour	See right	£16.17	£113.40	Red	8683	8673
Landscape clear enclosed holder with thumb ejection slot	7172	£40.10	£319.04	Green	8684	8674
Portrait clear enclosed card holder with thumb ejection slot	7174	£40.10	£319.04	Yellow	8685	8675
Rigid clear card holder with belt clip	7170	£32.30	£270.13			

INDEX

A		Business Card Boxes	94	D	
Acetates	34	Business Card Pockets	60	Digital Laminates	7
Adhesive Pockets	60	C		Dispensers - Leaflet	69
Adhesives - Dots	49	C Hooks	74	Display Clips/Fixings	74
Adhesives - Glues	55	Cable Ties	68	Display Wobblers	73
Adhesives - Tapes	40	Calendar Binding Kits	29	Docs Enclosed Wallets	94
Angled Pocket	60	Calendar Cases	39	Dots - Glue	49
Anti-Static Brush	81	Calendar Hangers	38	Double Ended Tassels	63
ATG Tape Kits	48	Calendar Windows	38	Double Sided ATG Tape	47
ATG Tapes	46	Calliper	81	Double Sided Tapes	40
B		Card Boxes	94	Drill Bits	82
Badge Holders - Pin/Clip	101	Card Covers	34	Drilling Accessories	84
Badge Wallets Plastic	101	Card Holder Pockets	60	Drilling Sticks & Discs	84
Ball Chain	66	Card Holders - Rigid	101	E	
Banner Eyelets	80	Card Wallets - Plastic	60	Eco Paper Binding Covers	35
Banner Hemming Tape	42	Cases for Media	71	Elastic Bands	96
Banner Stands	70	CD Calendar Case	39	Elastic Reels	62
Billy Blob Type Dots	49	CD Cases & Boxes	71	Elasticated Cord	62
Binding Coils	33	CD Fixings & Fittings	71	Elasticated Loops	62
Binding Combs	32	CD Pockets	61	Encapsulation Films	15
Binding Covers	34	Ceiling Clips	75	E-tape	52
Binding Machines - Coil	33	Ceiling Hangers	75	Etona Staples	87
Binding Machines - Comb	32	Cellophane Envelopes	93	Euro Slot Punch	88
Binding Machines - Wire	30	Chain	66	Euro Tabs	74
Binding Pockets	36	Chicago Screws	64	Extending Hooks	76
Binding Rings	67	Coils - Plastic	33	Extension Screw Posts	65
Binding Screws	64	Cold Seal Pouches	13	Exterior Tapes	44
Binding Wires - Premium	22	Coloured Elastic	62	Eyelets - Banner/Sail	80
Binding Wires - Renz	26	Comb Bindings	32	Eyelets - Small	78
Binding Wires - Spools	24	Cord - Elastic & Rayon	62	Eyeletting Machines	78
Binding Wires - Trade	20	Corner Pockets	60	Eyeletting Tools	79
Blades - Guillotine	85	Cornering Machine	89	F	
Blades - Knives	90	Creasing	89	Fanapart Adhesive	55
Blades - Scalpel	90	Crocodile Clip & Strap	99	Fastback Strips	37
Bookbinding Tape	49	Crystal Discs	54	Filing Strips/Prongs	37
Bookmark Tassels	63	Cups - Suction	77	Filing Pockets	36
Boxes - Cardboard Ream	95	Cutting Mats	91	Fingerlift Tape	41
Boxes - Plastic	95	Cutting Sticks - Drill	84	Foam Tape/Pads	45
Brass Screws	64	Cutting Sticks - Guillotine	84	Folders - Presentation	35
Breakaway Lanyards	97			Folding Bones	89

Frames - Snap	76	K	Nickel Screws	64	
G		Key Rings	100	Nylon Security Loops	68
Gauze	55	Knives - Cutting	90	Nylon Thread	75
Gloss Laminating Film	7	Knives - Padding	55	O	
Gloss Pouches	12	L	OPP Laminating Film	7	
Glue Dots	49	Labels - Clear Round	54	P	
Glue Dots - applicator	46	Laminating Films	7	Packaging Knife	90
Glue Dots - dispenser	49	Laminating Machines	11	Packaging Tapes & Guns	52
Glue Sticks - hot melt	55	Laminating Pouches	12	Padding Brushes/Knives	55
Glue Tape	44	Laminators	14	Padding Glue	55
Glues - Padding/Binding	55	Lanyards	97	Padding Press	55
Glues - Tapes	44	Leaflet Dispensers	69	Pallet Wrap Film	96
Greetings Card Envelopes	93	Lever Arch Folders	36	Paper Ream Boxes	94
Grip Seal Bags	93	Lever Clip & Strap	99	Paper Trimmers	92
Guarantape	40	Lihit Drill Bits	83	Perforated Labels	54
Guillotine Blades	85	Linson Spine Tape	49	Perforator - Hand	91
Guillotine Cutting Sticks	84	Literature Dispensers	69	Pin & Clip Fittings	99
Gun - ATG Tape	46	Loop Clips	67	Pin Badge Holder	101
Gun - Packaging Tape	52	Loops - Elastic	62	Plastic Badge Holder	101
H		Loose Leaf Rings	67	Plastic Banner Eyelets	80
Hammer	81	Luggage Tags/Loops	100	Plastic Binding Coils	33
Hand Eyeletter	78	M		Plastic Binding Screws	65
Hand Perforator	91	Magnetic Discs	58	Plastic Card Boxes	95
Handy Wrap	96	Magnetic Fixings	59	Plastic Combs	32
Hanging Tabs	74	Mailing Bags	93	Plastic Covers	34
Header Tabs	74	Masking tape	53	Plastic Envelopes	93
Hemming Tape	42	Mats - Cutting	91	Plastic Pockets	60
Hi Tack Tapes	42	Matt Laminating Film	7	Plastic Wobblers	73
Hinged Rings	67	Matt Pouches	13	Pockets	60
Hole Punch	88	Medical Filing Clips	37	Point of Sale Fittings	74
Holographic Films	9	Measuring Calliper	81	Poly Mailing Bags	93
Hook & Loop Tape/Dots	50	Menu Tassels & Loops	63	Polyester Tape	44
Hook Tabs	74	Metal Discs - Magnetic	58	Pop Up Banner Stands	70
I		Metal Screws	64	Post Screws	64
Ibiwire	28	Metal Wobblers	73	Poster Holders - Wall	76
ID Cardholders	101	Minifix Clip	67	Poster Holders - Three Sided	70
Identity Fittings	97	Multi Tapes	49	Pouch Laminators	14
Identity Lanyards	97	N		Pouches	12
Interscrews	64	Nagel Staples	86	Premium Lanyards	97
J		Neck Lanyards	97	Premium Wires	22
Jewel Cases	71	Necklace Chains	100	Presentation Ring Binders	35
Job Card Pockets	60	Nickel Ball Chain	66	Printed Lanyards	98
Jogger Blocks	85	Nickel Binding Rings	67		

R		Snap Fasteners	67	Tagging String & Wire	68
Rapid Staples	86	Soft Touch Laminate	8	Tape - Bookbinding/Spine	49
Rayon Cord	63	Specials	56	Tape - Double Sided	40
Ream Boxes	94	Spiders - CD	71	Tape - Glue	44
Renz Binding Wires	26	Spine Tape	49	Tape - Magnetic	58
Retracting Knives	90	Spine Tassels & Loops	63	Tape Cutting Machine	48
Ribbon	63	Spiral Bindings	33	Tape Guns - ATG	46
Ring Binders	35	Split Ring	100	Tape Guns - Packaging	52
Ring Mechanisms	36	Spools of Binding Wire	24	Tassels	63
Roll Laminators	11	Spools of Stitching Wire	88	Teflon Drill Bits	82
Roller Banner Stands	70	Spraymount	55	Thermal Binding	37
Rotary Trimmers	92	Spring Clips	99	Thimblettes	91
Round Cornering	89	Spring Wobblers	73	Thumbcut Punch	38
Rubber Bands	96	Staples	86	Thumbtack Suction Cups	77
Rudder Struts	72	Stapling Machines	87	Trade Binding Wires	20
Ruler - Steel	81	Stapling Wire	88	Trade Specials	56
S		Static Solutions	81	Treasury Tags	68
S Hooks	74	Steel Binding Rings	67	Triangle Pockets	60
Sail Eyelets & Tools	80	Steel Rulers	81	Tungsten Drill Bits	82
Scalpel & Blades	90	Sticky Discs - Clear	54	W	
Scotch Tape	53	Sticky Pockets	60	Waxing Paper	84
Screw Posts	64	Sticky Tapes	40	Wire - Stitching	88
Screws, Binding	64	Stitching Wire	88	Wire - Tagging	68
Security Loops	68	Stretchwrap Film	96	Wire Binding Machines	30
Self Seal Pouches	13	String	68	Wire Bindings	19
Sellotape	53	Struts - for Showcards	72	Wire Ceiling Clips	75
Serrated Edge Screws	65	Studs for Swatches	66	Wire Cutters	38
Showcard Struts	72	Suction Cups	77	Wiro Binding Wires	19
Shrinkfilm	96	Swatch Fasteners	66	Wobblers	73
Shrinkwrap Film	96	Swatch Rings	67		
Signmaking Tapes	44	T			
Silicone Spray	84	T Clip	75		
Slot Punch, Euro	88	T Shaped Wobbler	73		
Small Eyelets	78	Tabs - Hanging	74		

This is a trade priced catalogue and all prices shown exclude VAT. Please see online for latest delivery costs and options. Prices can change without notice, current pricing can be found online at presco.eu. Order by 4pm for next day delivery. Full Terms & Conditions of sale available online.

Presco UK Ltd, Kiln Lane, Swindon, SN2 2NP.

TERMS AND CONDITIONS

Please visit our website at presco.eu for terms and conditions, current pricing and other information.



ARE YOU A BIG USER OF FINISHING PRODUCTS?

Get discounted prices on big orders, binding wire spools and any regular consumables. We look after our customers and will give you the best deal possible on pricing and top service every single order.

Speak to our team now or email for more information – sales@presco.eu

Order online 24/7 for **FAST** delivery [presco.eu](https://www.presco.eu)

ENVELOPE SIZES		PAPER SIZES					
Envelope Type	Size (mm)	Sheet type	Size (mm)	Sheet type	Size (mm)	Sheet type	Size (mm)
C3	324x458	A0	841x1189	RA1	610x860	B1	707x1000
C4	229x324	A1	594x841	RA2	430x148	B2	500x707
C5	162x229	A2	420x594	SRA0	900x1280	B3	353x500
C6	114x162	A3	297x420	SRA1	640x900	B4	250x353
C7	81x114	A4	210x297	SRA2	450x640	B5	176x250
DL	110x220	A5	148x210	SRA3	320x450	B6	125x176
		A6	105x148	B0	1000x1414		
		A7	74x105				
		RA0	860x1220				

Catalogue and all content copyright © Presco 2019.

We put customers first.
Check out our latest
reviews on **Trustpilot.com**



**Quick and free sample.
Good quality products and
very available for any queries
you may have after.**

Amelia H, June 2019

**Brilliant service and so quick.
Really happy. Thank you!**

CornishGal, May 2019

**Excellent Service as always
– first rate company with
difficult to source products –
always delivers on time.**

Brian H, May, 2019

**I ordered binding screws
for a project. They arrived
the next day as promised
and are of high quality.
Thank you.**

Elizabeth M, May 2019

**Great company! Very helpful
staff, brilliant service and
would highly recommend.**

Victoria L, March 2019

**Excellent products at
brilliant prices. This
company is definitely worth
bookmarking. I highly
recommend them.**

H ROL, May 2019

FOR HELP, ADVICE & SAMPLES

 01793 716300  sales@presco.eu  presco.eu

Presco

Finishing & Presentation Solutions